

RDS Forum - the association of RDS users

SPB 490
Final version 6.02

UECP

RDS Universal Encoder Communication Protocol



FOREWORD

This version of the Universal Encoder Communications Protocol specification is a development undertaken by the RDS Forum, following a request from the membership to upgrade the former version, previously in use.

So this version of the specification is derived from the jointly published EBU and RDS Forum specification: "SPB 490 5th Revision RDS Universal Encoder Communication Protocol, UECP Version 5.1, dated 22.08.97".

This version of the specification is based upon version 5.1 and is wholly backwards compatible, in respect of previous models, architecture and Message Element Commands (MEC). New MECs for ODA configuration and data have been added and it now clarifies for new users the position of certain MECs, which are effectively superseded by new commands.

This specification continues with the former objectives to satisfy the need for harmonised RDS encoder communication protocols to facilitate the inter-working of various RDS systems components such as RDS servers, data bridges and encoders, regardless of the supplier. Furthermore a harmonised network environment and encoder model is maintained to further facilitate the interchange of component parts of RDS network systems.

This specification describes these harmonized models and a universal layered protocol, based on the ISO/OSI recommendation, which encompasses all current RDS features, and can also accommodate new developments.

The model and protocol provide a template specification upon which new products may be based. An RDS server or encoder does not need to implement all the features described, but any feature implemented must be made in accordance with this specification.

The RDS Forum wishes to place on record its thanks to all those who have contributed to the elaboration of this specification.

Geneva (Switzerland), June 2003

Dietmar Kopitz, CEO RDS Forum
dkopitz@compuserve.com

CONTENTS

1.	Environmental model	5
1.1	Addressing method	5
1.2	Encoder model	7
1.2.1	Software model	7
1.2.2	Hardware model	8
1.3	Transmission modes	9
1.3.1	Uni-directional mode	9
1.3.2	Bi-directional mode, requested response	9
1.3.3	Bi-directional mode, spontaneous response	9
2.	Protocol description	10
2.1	Physical layer	10
2.1.1	Mechanical specification	10
2.1.2	Signal description	11
2.1.3	Data format	12
2.2	Data Link Layer	12
2.2.1	General Frame Format	12
2.2.2	Start (STA)	13
2.2.3	Address (ADD)	13
2.2.4	Sequence Counter (SQC)	14
2.2.5	Message field length (MFL)	14
2.2.6	Message (MSG)	14
2.2.7	Cyclic Redundancy Check (CRC)	14
2.2.8	Stop (STP)	14
2.2.9	Byte-stuffing method	15
2.3	Message field format	15
2.3.1	Message structure	15
2.3.2	Message Element Code (MEC)	16
2.3.3	Data Set Number (DSN)	16
2.3.4	Programme Service Number (PSN)	16
2.4	Message codes	16
2.4.1	Remote and configuration commands	16
2.4.2	RDS messages	16
2.4.3	Status messages	17
2.4.4	Specific messages	17
2.5	Description of data handling	17
2.5.1	Group sequence	17
2.5.2	Handling of data in paging mode	18
2.5.3	Handling of ODA data	18
3.	Message description	20
3.1	List of all defined commands	20
3.2	Command format	22
3.3	Command repertoire	22

Appendix 1	
CCITT Polynomial	113
Appendix 2	
Glossary	115
Index of abbreviations	119
Appendix 3	
Identification of manufacturers and transmission operators for the Manufacturer's specific command	121
Index of RDS message commands	122
Document history	123

1. Environmental model

1.1 Addressing method

Communication to RDS encoders needs to be capable of many levels of addressing: to all encoders, to specific sets of encoders or to a particular device. This may be accomplished by unique physical connections or by a suitable logical addressing method.

In defining an environmental model for the universal protocol, the following assumptions are made:

The data stream will feed one or more transmitter sites. Each site will have a unique address, known as the **site address** (a number in the range 1-1023). All encoders at a particular transmitter site share the same site address.

An encoder will possess one or more site addresses. One of these must be unique to the particular physical site location. Additional site addresses are permitted for a particular area, region, or country.

To clarify this concept, an example is given. All encoders at the NEWTOWN site have the unique site address "123". Other encoders in the system are not permitted to use this address. Encoders at the NEWTOWN site also have the site address "267", which is allocated to all encoders in the LAKEVALLEY area. Messages arriving at the NEWTOWN site with either of these two site addresses will be accepted. Messages arriving at the LITTLEVILLAGE site (address "452"), also in the LAKEVALLEY area, will not be accepted if they carry the NEWTOWN site address, but will be accepted if they carry either the LITTLEVILLAGE or the LAKEVALLEY site address.

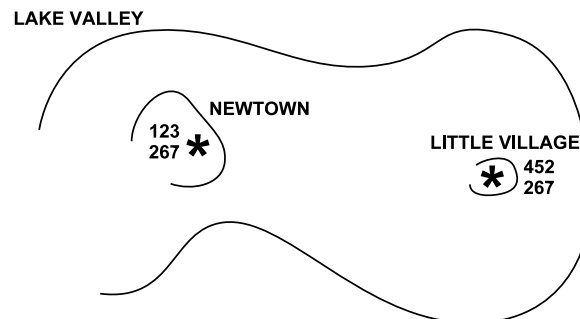

Fig. 1: Fictitious example of site addressing

Several RDS encoders are installed at each transmitter site, serving a number of programme services. Backup equipment is sometimes provided, sometimes not. A single backup encoder may even be provided for several programme services. Whatever the situation may be, each encoder at the site needs to be individually addressable. A second level of addressing is therefore introduced, the **encoder address** (a number in a range 1-63).

An encoder will possess one or more encoder addresses. One must be unique to the encoder at that site. Additional encoder addresses may be assigned according to the encoder's usage or manufacture. However, the site and encoder addresses are not intended to specify a particular radio service. The specification of a particular radio service, a third level of addressing, is accomplished by using a **programme service number**, defined in Section 1.2.1. The site and encoder addresses should be thought of as being entirely physical, and are used only to address a certain "box" at a certain location, the functionality of the "box" is irrelevant in this context.

It is expected that many messages will be sent to all encoders. Thus, the **global** number of "0" is defined for both the site and encoder addresses. Messages bearing the global site address are deemed to be acceptable at all sites in the system. Messages bearing the global encoder address are deemed to be acceptable at all encoders at sites specified by the accompanying site address.

An encoder will have two address lists, one of acceptable site addresses and the other of acceptable encoder addresses. The site address list includes "0" (the global site address), the unique site address and any additional site group addresses. The encoder address list includes "0" (the global encoder address), the unique encoder address and any additional encoder group addresses.

A message is acceptable to a particular encoder only if the site address is contained within its site address list and the encoder address is contained within its encoder address list.

1.2 Encoder model

1.2.1 Software model

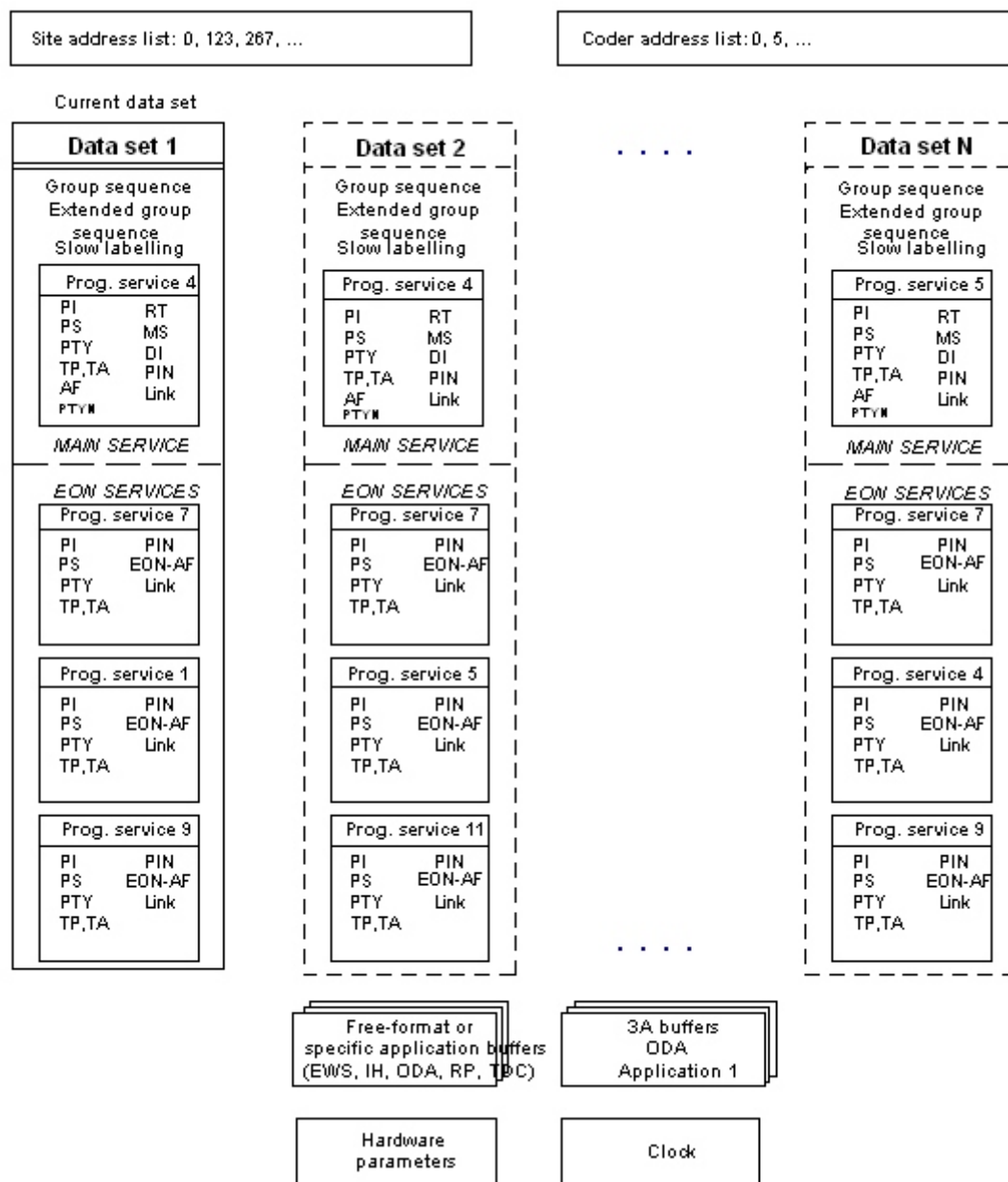

Separate buffers are required for all group types.

Fig. 2: RDS Encoder Software Model

Messages are accepted by the encoder in accordance with the addressing method described in Section 1.1. Applicability is further determined by optional fields within the message itself. This permits addressing of the following structures within an encoder:

Data sets: An encoder will have one or more **data sets**, each of which results in a particular RDS output. Each data set may refer to many programme services using the RDS EON feature. Only one data set is responsible at any one time for the encoder's output and is known as the current data set. Data sets are addressed by the protocol as described in Section 2.3.2.

Programme services: All programme services are identified by a unique programme service number which is used to label data within RDS networks. In a network providing the EON feature, data for several programme services will be sent to an encoder which may then identify that the data refers to one or more of the data sets and elements within the data sets used by that encoder. Programme services are addressed by the protocol as described in Section 2.3.3. There is a specific memory area in each data set for each programme service.

Buffers: Some information is buffered, for example EWS, IH, TDC, TMC and Free Format Groups. This means that the received information is placed in a queue awaiting transmission. It is possible to configure a buffer for cyclic transmission.

1.2.2 Hardware model

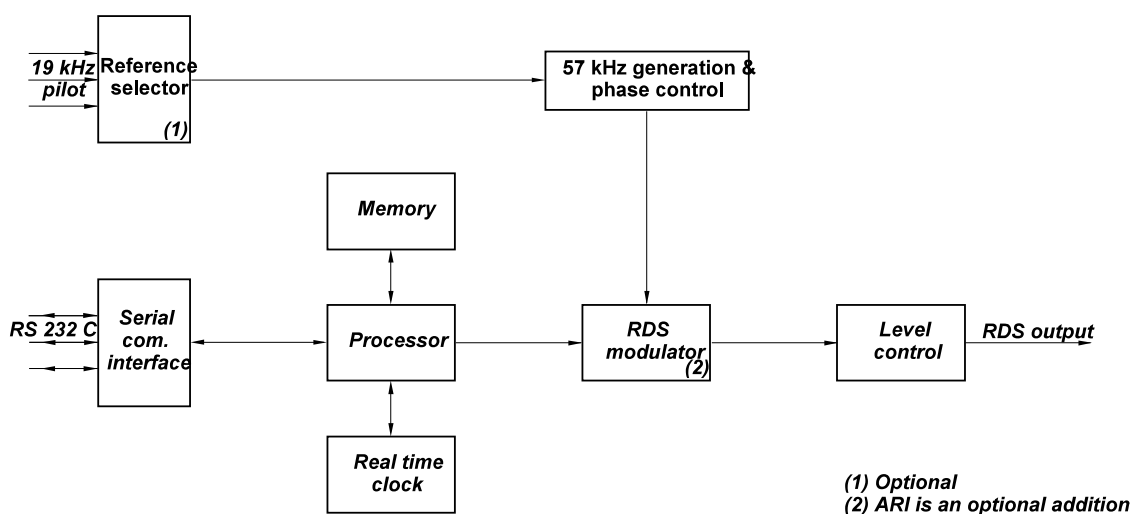

Fig. 3: RDS Encoder Hardware Model

A simplified model of an RDS encoder has been used in the development of this universal protocol and is shown in Figure 3. The model does not include such obvious or necessary components as a power supplier or control panel, but includes only the blocks necessary to understand and develop the protocol itself. These are:

Processor: The central processing unit of the encoder, usually a micro-processor, with access to input and output devices, the real-time clock, and memory.

Memory: Comprises ROM and RAM necessary for the operating software of the encoder, and appropriate RAM, NVRAM, and ROM for stored data.

Real time clock: Maintains the current time of day and calendar date. Used to generate type 4A groups (CT).

Serial communication interface: Data, according to this protocol, is received and transmitted using the serial communications interface.

RDS modulator: Produces the RDS bi-phase signal, and optionally ARI in accordance with IEC EN 62106:2000 / EN 50067:1998.

57 kHz oscillator: Frequency and phase locked to the third harmonic of the selected reference source.

Reference selector (optional): Selects one source of 19 kHz reference signal, out of a maximum of six, to lock to the internal 57 kHz oscillator. Each 19 kHz reference source corresponds to a specific level and phase adjustment of the produced output signal. When a specific reference source is selected via the Reference selector, the corresponding level and phase values are taken from a "reference entry table". This table comprises the following parameters:

- RDS output level
- RDS phase
- ARI level (if implemented)

Level and phase control: The level and phase of the RDS signal (optionally ARI) may be adjusted by the processor under the appropriate commands (see pp. 47 and 48). The Output level may be set in the range 0 to 8191 mV, and the phase in the range between 0 and 360 degrees to lock to the internal 57 kHz oscillator. Level and phase of the RDS signal may depend of the 19 kHz reference signal. As up to six reference inputs may be used, level and phase are set on the "reference table entry", as mentioned under Reference selector.

1.3 Transmission modes

The universal protocol is designed to operate in various communication modes as follows:

1.3.1 Uni-directional mode

This mode is used on one way communication links. Data is transmitted to one, a group or all encoders. Answer back is not required.

1.3.2 Bi-directional mode, requested response

This mode uses a two-way communication link to transmit data to one, a group or all encoders. It enables the server to request data, status, and error report from encoders.

1.3.3 Bi-directional mode, spontaneous response

A two-way communication link enables a server to transmit data to encoders, and request data from encoders. Encoders are also able to spontaneously generate status and error messages. Such messages, their content and application are described in Section 3.

2. Protocol description

2.1 Physical layer

Specification at this level is necessary to ensure electrical and mechanical compatibility of equipment. Interfacing to the encoder is accomplished with a serial interface based on the well-known standard EIA RS 232C (compatible with V24/V28). This is a full-duplex interface with hardware handshaking, able to operate with modems.

2.1.1 Mechanical specification

The encoder should be equipped with either the 25-pin SUB-D or the 9-pin SUB-D connectors. The 9-pin SUB-D connector would be preferred. Converting between the two types of connectors is easily done via commonly available adapters. The interface is designed as a DTE (Data Terminating Equipment) and therefore the connectors should be of a male type.

Signals on the 9-pin connector for DTE (IBM-compatible) are given in Table 1.

Table 1

Pin	Signal	I/O	Signal description
1	DCD	I	Data Carrier Detect (optional)
2	RxD	I	Received Data
3	TxD	O	Transmitted Data
4	DTR	O	Data Terminal Ready
5	GND	-	Signal Ground
6	DSR	I	Data Set Ready
7	RTS	O	Request to Send
8	CTS	I	Clear to Send
9	RI/+5...+15V	I/O	Ring Indicator (optional) or auxiliary supply voltage (optional)

Signals on the 25 pin connector for DTE are given in Table 2.

Table 2

Pin	Signal	I/O	Signal description
1	PE	-	Protection Earth
2	TxD	O	Transmitted Data
3	RxD	I	Received Data
4	RTS	O	Request to Send
5	CTS	I	Clear to Send
6	DSR	I	Data Set Ready
7	GND	-	Signal Ground
8	DCD	I	Data Carrier Detect (optional)
18	+5...+15V	O	Auxiliary Supply Voltage
20	DTR	O	Data Terminal Ready

2.1.2 Signal description

The specified interface is an electrical unbalanced circuit with signal levels according the EIA RS 232C.

The signals have the following functionality:

PE (Protection Earth):	Is available only on the 25-pin connector and should be tied to the encoder case internally
TxD (Transmitted Data):	Data from the encoder to an external device
RxD (Received Data):	Data from an external device to the encoder
RTS (Request to Send):	The OFF-State on this line is used to indicate to an external device to pause with data transmission on RxD until RTS is switched to the ON-State again (also called dynamic handshake)
CTS (Clear to Send):	The OFF-State on this line is used to indicate to the encoder to pause with data transmission on TxD until CTS is switched to the ON-State again (also called dynamic handshake)
DSR (Data Set Ready):	The ON-State on this line is used to indicate to the encoder that an external device is connected and is ready for operation (also called static handshake)
DTR (Data Terminal Ready):	The ON-State on this line is used to indicate to an external device that the encoder is ready for operation (also called static handshake)
GND (Signal Ground):	Analog Ground for the circuitry (not shield)
DCD (Data Carrier Detect):	This signal can be (optional) evaluated to detect an active modem
RI (Ring Indicator):	This optional signal can be evaluated to detect an incoming call from modem.
+5..+15V:	This (optional) signal is an auxiliary supply voltage for external low power devices, such as level converters or fiber optic devices, and should be current limited.

Remarks:

- If DTR/DSR signals are OFF, the corresponding RTS/CTS signals must also be in OFF-state.
- If hardware handshake is used, then it should work in this way. If it is not used, the system should be operated at a suitable data rates which guarantees that no characters are dropped.

2.1.3 Data format

The data is transmitted character by character in asynchronous mode.

Characters of 8 bits are transferred, preceded by 1 start bit and followed by 1 stop bit. No parity bit is included. Transmission speeds will be any of the following standard values 75, 150, 300, 600, 1200, 2400, 4800, 9600 and 19200, 38400, 57600, 115200 bps.

2.2 Data Link Layer

Update data comprises a stream of data frames. A frame comprises a series of bytes, delimited by two reserved bytes, which mark the beginning and end of the frame. Each frame contains a destination address, defining the set of encoders to which the record is being sent. A sequence counter labels each separate record. The message itself is preceded by a byte defining the message length, and followed by a CRC check.

The start and stop bytes are uniquely defined, and may not occur in any other fields of a frame. In order to prevent this, a frame is byte-stuffed prior to transmission. Byte-stuffing transforms an illegal occurrence of a reserved byte into two legal bytes. The reverse process is applied at reception, byte-stuffed frames are converted prior to frame processing. Thus, although the start and stop bytes are reserved, messages may freely use bytes with any value. In cases where reserved byte values are present in the message, the transmitted message length will be increased. However, the length of a message is always defined in its unstuffed, shortest, state.

2.2.1 General Frame Format

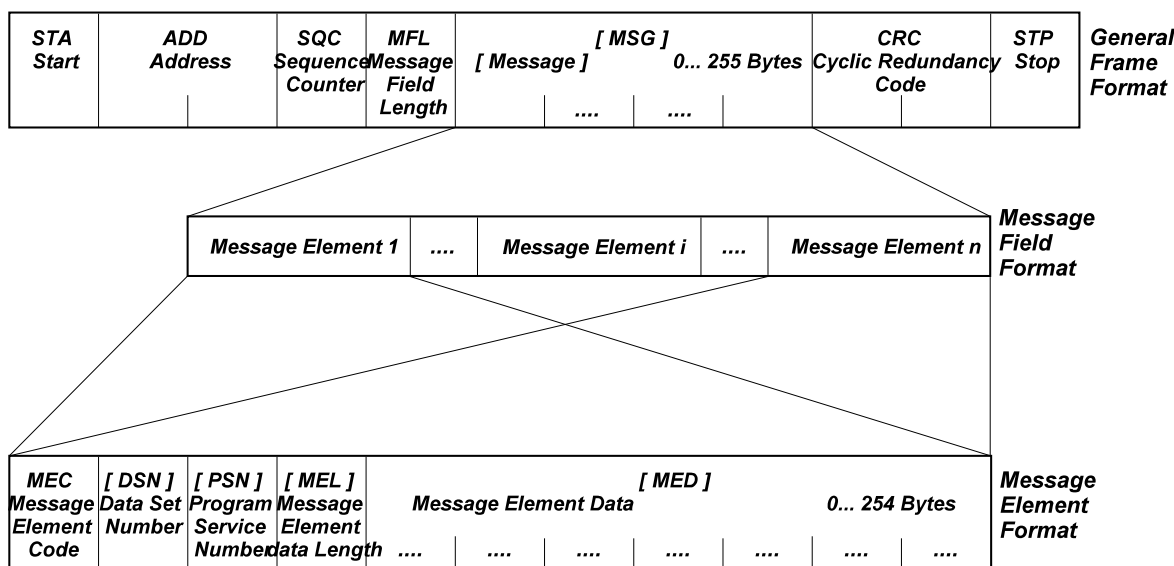

[] Fields in brackets are optional. Inclusion is inherently defined by the Message Element Code

Fig. 4: Data protocol format

Each data frame has the following format:

<u>Field Description</u>	<u>Descriptor</u>	<u>Field Length</u>
Start	STA	1 byte
Address	ADD	2 bytes
Sequence Counter	SQC	1 byte
Message field length	MFL	1 byte
[Message] ¹⁾	[MSG]	0...255 bytes
Cyclic Redundancy Check	CRC	2 bytes
Stop	STP	1 byte

Frames are built according to this structure, and then byte-stuffed prior to transmission. Byte-stuffing removes any occurrences of reserved bytes (FE and FF) within the fields "Address" to "Cyclic Redundancy Check" inclusively.

The complete frame is represented in Figure 4.

2.2.2 Start (STA)

A data record starts with the start byte (FE hex). This byte will not occur at any other point in a transmitted sequence (after byte-stuffing).

2.2.3 Address (ADD)

The address field comprises two elements, these are:

Site address	10 bits (most significant)
Encoder address	6 bits (least significant)

For a message to be acceptable to a particular encoder both the site address and the encoder address must be contained within the respective address lists of the encoder.

2.2.3.1 Site address

The site address defines the site, or group of sites to which this record is being sent.

0	=	All sites
1-3FF hex	=	Specific site or group of sites, as selected by encoder operator.

Each encoder will acknowledge a series of site address codes. One must be unique, i.e. common to all encoders at a particular location. Another may be common to all encoders in a certain area and so on.

¹⁾ The symbols [] indicate that this field is optional. When not included the message field length will be set to zero. Such a record may be used to indicate an idle line.

2.2.3.2 Encoder address

The encoder address defines to which encoder(s) at a particular site this record is being sent.

0 = All encoders at the site

1-3F hex= Specific encoder or group of encoders, as selected by the encoder operator.

Each encoder will acknowledge one or more encoder address codes. One must be unique (i.e. at that site), another may be common to all encoders providing a certain RDS facility and so on.

2.2.4 Sequence Counter (SQC)

Each frame transmitted may be assigned a sequential number in the range 01-FF hex. Repetitions of any given frame, transmitted to increase data reliability in a simplex system or by request in a duplex system, can be assigned the original sequence number. Such repetitions must be completed before the current sequence counter, i.e. that used for new frames, is 100 decimal steps in advance, in order to avoid confusion between a repeat and a new record from a subsequent sequence. In the duplex mode the absence of a number in a received sequence may be used to request repetition of the particular record. If the sequence counter is not used, this field should be set to 00 hex.

2.2.5 Message field length (MFL)

This single byte informs the encoder of the number of bytes in the message field. This length is defined as that prior to byte-stuffing.

2.2.6 Message (MSG)

The message comprises 0 to 255 bytes of data. These bytes may freely take any value in the range 00-FF hex. Byte stuffing is applied afterwards (see 3.2.9.). The message field format is defined in Section 2.3.

2.2.7 Cyclic Redundancy Check (CRC)

The check field consists of two bytes (prior to byte-stuffing) which represent the result of a 16-bit cyclic redundancy check (CRC) calculation.

The divisor polynomial used to generate the CRC is the CCITT polynomial, $x^{16} + x^{12} + x^5 + 1$. The CRC calculation starts with the most significant bit of the first byte of the address field, and ends with the least significant bit of the last byte of the message field. The CRC is initialized to a value of FFFF hex, and the two check bytes are formed from the inverse of the result. The eight most significant bits are represented by the first check field byte, and the eight least significant bits are represented by the second check field byte (see also Appendix 1).

2.2.8 Stop (STP)

A data record ends with the stop byte (FF hex). This byte will not occur at any other point in a transmitted sequence (after byte-stuffing).

2.2.9 Byte-stuffing method

The technique of byte-stuffing allows a byte oriented protocol such as this to preserve certain unique values for framing purposes, and yet allow conveyed messages to utilize the full byte range (00-FF hex). This is achieved by trapping reserved bytes in illegal fields, and transforming them into legal byte pairs.

Byte values FD hex, FE hex, and FF hex are trapped in the fields "Address" to "Cyclic Redundancy Check" and transformed into a pair of bytes as shown in Table 3.

Table 3

Byte		Resultant byte pair
FD	transformed into	FD 00
FE	transformed into	FD 01
FF	transformed into	FD 02

Thus, the reserved bytes (FE and FF) will never occur within these fields in a transmitted record, and will only occur within the start and stop fields.

When a message is received, the reverse technique is used to transform two-byte sequences (always starting with FD hex), into single bytes prior to the record being processed.

2.3 Message field format

2.3.1 Message structure

The message field, if non-zero in length, consists of one or more message elements. Each message element has the structure as shown in Table 4.

Table 4

Field description	Descriptor	Field length
Message Element Code	MEC	1 byte
[Data Set Number] ²⁾	[DSN] ²⁾	0...1 byte
[Programme Service Number] ²⁾	[PSN] ²⁾	0...1 byte
[Message Element data Length] ²⁾	[MEL] ²⁾	0...1 byte
[Message Element Data] ²⁾	[MED] ²⁾	0...254 bytes

Several message elements may be packed together into one message field, subject to a maximum message field length of 255 bytes, as defined in Section 2.2.1. An individual message element must not be split between different message fields.

The complete message field may be represented as follows:

MEC,[DSN],[PSN],[MEL],[MED],[[MEC,[DSN],[PSN],[MEL],[MED]], ...

Fields and whole message elements shown in square brackets are optional. Message elements may be concatenated freely, subject to a maximum message field length of 255 bytes.

²⁾ The symbols [] indicate that this field is optional. They are used, as required by the specific command. See Section 3.

The maximum available length for a message element is 255 bytes. This inherently limits the message data to 254 bytes. If the optional fields "Data Set Number", "Programme Service Number", and/or "Message element data length" are utilized, further reduction to the maximum data length will occur. For example, if all optional fields are employed, the maximum data length will be 251 bytes.

2.3.2 Message Element Code (MEC)

The Message Element Code identifies a particular message, as defined in Section 3. The Message Element Code is within the range 01..FD. The codes 00, FE and FF are not permitted for defining a MEC, as they are used in this specification with a special meaning, always defined in the conventions for a specific command.

2.3.3 Data Set Number (DSN)

The Data Set Number (DSN) permits a message to be targeted to the following within an encoder:

- a specific data set,
- the current data set,
- all data sets.

The DSN within a message element is chosen as shown in Table 5.

Table 5

Data Set Number (DSN)	Target
0	Current data set
1-253	Specific data set
254	All data sets except the current data set
255	All data sets

2.3.4 Programme Service Number (PSN)

The Programme Service Number (PSN) permits a message element to operate a number of services within one or more data sets and the corresponding addressing is shown in Table 6.

Table 6

Programme Service Number (PSN)	Target
0	Special PSN for main service of specified data set(s)
1-255	Specific service within data set(s)

2.4 Message codes

Message codes are described in Section 3. Different classes of message are thus identified.

2.4.1 Remote and configuration commands

These commands permit to control the various functionality options of encoders or permit to request messages from the encoders in a case of bi-directional transmission mode.

2.4.2 RDS messages

These messages are related to all the RDS features which have to be processed by an encoder.

2.4.3 Status messages

These messages are used in bi-directional transmission mode to transmit information from an encoder to another device.

2.4.4 Specific messages

These types of messages are not allocated in this specification and concern specific and internal functionality which can be needed by encoder manufacturers. Specific code are reserved for these types of message and should not be used for other features.

2.5 Description of data handling

The data is transmitted to the encoder using the specified commands described in Section 3, and stored in memory according to the encoder software model (see Section 1.2.1).

2.5.1 Group sequence

The encoder must be told about the types of groups to be transmitted and about the appropriate transmission rate for every transmitted group type.

This is achieved with the "Group sequence" command, which is treated by the encoder like a group enable command. When a specific group is encountered in the sequence, data relating to that type is transmitted if available. The "extended group sequence" command enables alternative groups to be transmitted if the specific group type is not available. If no alternative group is specified then the group type is not generated and the next group type in the sequence is used instead.

With this method also the desired repetition rate for every group type is implicitly defined in a very flexible way for the broadcaster. There are, however, special transmission conditions which are described in the following sub-sections.

2.5.1.1 Insertion of type 4A group (CT)

The type 4A group is not allowed in the group sequence. If the CT function is set to On-State (see CT-On/Off command) a type 4A group is inserted automatically by the encoder at the edge of the minute.

During the insertion of a type 4A group, the given group sequence is suspended for this one group. This action has highest priority over any other event (e.g. inserting a type 14B group due to the change of TA flag).

If the CT function is set to the Off-State and the encoder is in the paging mode, type 4A groups with zero-bits for the time information will be transmitted every minute. If the encoder is not in paging mode, no type 4A groups will be transmitted.

2.5.1.2 Handling of type 1A group

If the encoder is in the non-paging mode, the type 1A group is processed as given in the group sequence and is treated like any other group type.

2.5.1.3 Insertion of type 14B group

The type 14B group is not allowed in the group sequence. In order to turn "on" the TA flag for EON services, type 14B groups are inserted automatically by the encoder as controlled with the EON TA control command, interrupting the given group sequence as a consequence.

If the encoder is in the paging mode, type 1A and 4A groups, for marking the intervals, have the highest priority. In the worst case, the inserted type 14B groups are delayed.

2.5.1.4 Insertion of type 15B group

Similar to the insertion of type 14B groups, type 15B groups are inserted automatically by the encoder as controlled with the TA control command when the TA flag for the main service changes.

If the encoder is in the paging mode, type 1A and 4A groups, for marking the intervals, have the highest priority. In the worst case, the inserted type 15B groups are delayed.

2.5.2 Handling of data in paging mode

If the group sequence contains a type 7A group, and 7A is not declared for ODA (see 3.3.14), the encoder is in the paging mode.

If the encoder is in the paging mode, a type 1A group is transmitted every second and is also marking every paging interval. This is done by the encoder automatically when in paging mode. In order not to influence this structure, the given type 1A groups in the group enable sequence are ignored. The transmission of a type 1A group every second (in conjunction with a type 4A group at the edge of the minute) has priority over all other events.

Each paging interval contains a maximum of 48 type 7A groups. When EPP is used, one or two 7A groups at the beginning of the interval are replaced by 13A groups. These are transmitted immediately after the first 1A group at the beginning of the interval (4A group for interval 0).

2.5.3 Handling of ODA data

The introduction of open data applications to the RDS standard IEC EN 62106:2000 / EN 50067:1998 offers a very flexible way of setting up new (and maybe unknown) applications using RDS. This in turn however requires a very flexible means of allocating resources to ODA and dealing with possible conflicts of priority for different applications.

RDS resource allocation: The transmission of data according to the group sequence and extended group sequence does not offer the timing constraints necessary for certain OD Applications and so two additional mechanisms have been included to increase the flexibility of the RDS resource allocation: "Burst Mode" transmission and "Spinning wheel" mode transmission.

"Burst mode" transmission: This mode enables ODA free-format groups to be transmitted like 14B and 15B groups with a predetermined number of repetitions and inter-group spacing.

"Spinning wheel" mode transmission: The so called "spinning wheel" technique is based on the following ideas:

Divide the minute into an integer number of time slots.

Split each of these time slots into a first part (activity time, T_a), during which ODA groups may be inserted into the data stream and a second part (window time, T_w), during which no ODA groups shall be inserted into the data stream.

Between the start of the minute (as indicated in the RDS-data stream by the presence of the type 4A group, which must be transmitted for this technique) and the start of the first time slot, a delay is possible (delay time, T_d).

The meaning of the parameters T_a , T_d and T_w is illustrated below:

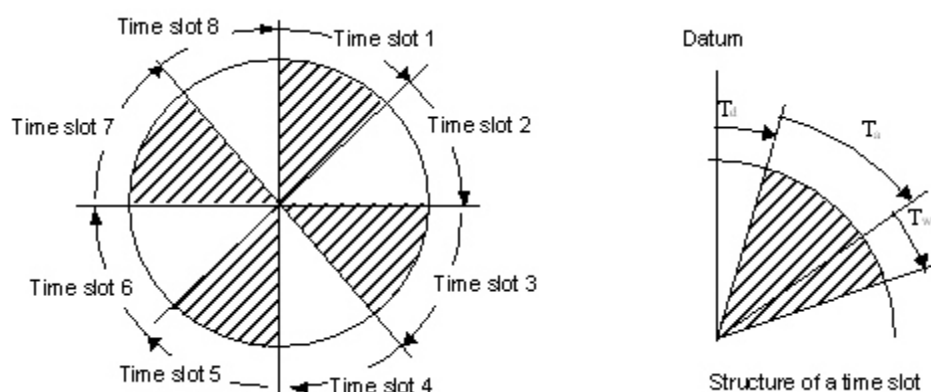

The insertion of ODA-groups is governed by the following rules:

No ODA groups should start outside the activity window.

An ODA group may be completed outside the activity time.

T_a , T_w , T_d have to be multiples of a second, with $60 \text{ s} / (T_a + T_w) = n$ (where n : integer > 0).

The actual values of these parameters should be assumed to be either default values or be coded into the system information.

Priority setting: In order to offer flexible priority setting for different OD applications the ODA free-format group is sent to the encoder with one of the following priorities: normal, "extremely urgent" or "immediate" transmission.

A group sent with normal priority will be added to the specified free-format group buffer for transmission according to the group sequence and resource allocation configuration. A group sent with "extremely urgent" priority will bypass the free-format buffer and will be sent as soon as possible according to the group sequence and resource allocation configuration. A group sent for "immediate" transmission is immediately transmitted irrespective of the group sequence, but respecting the higher priority of 1A and 4A groups.

The relative priority setting for different groups can also be configured in order to explicitly define the relative priority for groups competing to be transmitted outside of the group sequence: e.g. 14B, 15B and repetitions of ODA "Burst mode" groups.

3. Message description

2.6 List of all defined commands

	<u>Message Element Code</u>	<u>Page</u>
<u>RDS message commands</u>		
PI	01	23
PS	02	24
PIN	06	25
DI/PTYI	04	26
TA/TP	03	27
MS	05	28
PTY	07	29
PTYN	3E	30
RT	0A	31
AF	13	34
EON - AF	14	36
Slow Labeling codes	1A	38
Linkage information	2E	39
<u>Open Data Application commands</u>		
ODA configuration and short message command	40	40
ODA identification group usage sequence	41	42
ODA free-format group	42	44
ODA relative priority group sequence	43	46
ODA "Burst mode" control	44	47
ODA "Spinning Wheel" timing control	45	48
ODA data	46	50
ODA data command access right	47	53
<u>Transparent data commands</u>		
TDC	26	55
EWS	2B	56
IH	25	57
TMC	30	58
Free-format group	24	59
<u>Paging commands</u>		
Paging call without message	0C	60
Paging call with numeric message (10 digits)	08	61
Paging call with numeric message (18 digits)	20	62
Paging call with alphanumeric message (80 characters)	1B	63
International paging with numeric message (15 digits)	11	64
International paging with functions message	10	65
Transmitter network group designation	12	66
EPP transmitter information	31	67
EPP call without additional message	32	68
EPP national and international call with alphanumeric message	33	69
EPP national and international call with variable length numeric message	34	71
EPP national and international call with variable length functions message	35	73
<u>Clock setting and control</u>		
Real time clock	0D	75
Real time clock correction	09	76

	<u>Message Element Code</u>	<u>Page</u>
CT On/Off	19	77
<u>RDS adjustment and control</u>		
RDS On/Off	1E	78
RDS phase	22	79
RDS level	0E	80
<u>ARI adjustment and control</u>		
ARI On/Off	21	81
ARI area (BK)	0F	82
ARI level	1F	83
<u>Control and set up commands</u>		
Site address	23	84
Encoder address	27	85
Make PSN list	28	86
PSN enable/disable	0B	87
EON elements enable/disable	3F	88
Communication mode	2C	89
TA control	2A	90
EON - TA control	15	91
Reference input select	1D	92
Data set select	1C	93
Group sequence	16	94
Extended group sequence	38	95
Group variant code sequence	29	97
PS character code table selection	2F	98
Encoder access right	3A	99
Communications Port Configuration - Mode	3B	101
Communications Port Configuration - Speed	3C	103
Communications Port Configuration - Timeout	3D	105
<u>Bi-directional commands (Remote and configuration commands)</u>		
Message acknowledgment	18	107
Request message	17	109
<u>Specific message commands</u>		
Manufacturer / Transmission operator specific command	2D	111
Astra ADR ³⁾ special commands (Reserved range)	EC to FC	112

³⁾ The Astra ADR (Astra Digital Radio) specification is published by Société Européenne des Satellites, Luxembourg (<http://www.astra.lu>)

2.6 Command format (see the following pages)

First Column Second Column Third Column

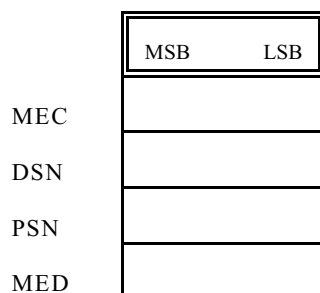

Conventions:

The message description is made according to the above diagram. The first column indicates the descriptor of the message which is detailed in the table (Second column).

Each element in the table represents one byte where the bits are numbered from 7..0 (from left to right). For transmission of a respective message each byte is represented by two hex symbols of which the permitted range is indicated in the respective element. The message structure used is explained in Section 2.3.1. Symbol 00..XX or 0..X, 0..X specifies the range of the hex value that may be used.

The third column gives information of the context of the table. Symbol hex means that any hex value may be used. Any other information describes the nature of the data which is put in the table.

The coding of all RDS features is in the same format as used in IEC EN 62106:2000 / EN 50067:1998, unless otherwise specified.

3.3 Command repertoire (see the following pages)

The following pages detail each command, in the order listed in Section 3.1. This is not in any particular order but has been subdivided into groups of common interest. Where there are associated request messages these are also shown.

3.3.1 Message Name: PI

Message Element Code: 01

Function: To set the PI code of the specified programme service(s) of the specified data set(s).

Format:

	MSB	LSB	
MEC	01		
DSN	00..FF		
PSN	00..FF		
MED	00..FF		PI (MSB)
MED	00..FF		PI (LSB)

Conventions: Coding of PI is according to IEC EN 62106:2000 / EN 50067:1998.

Example: <01><00><01><C2><01>

Set PI code in current data set for programme service 1 to C201.

3.1.1 Message Name: PS

Message Element Code: 02

Function: To set the PS name of the specified programme service(s) of the specified data set(s).

Format:

	MSB	LSB	
MEC	02		
DSN	00..FF		
PSN	00..FF		
MED	20..FE		PS Character 1
MED	20..FE		PS Character 2
MED	20..FE		PS Character 3
MED	20..FE		PS Character 4
MED	20..FE		PS Character 5
MED	20..FE		PS Character 6
MED	20..FE		PS Character 7
MED	20..FE		PS Character 8

Conventions: Coding of PS is according to IEC EN 62106:2000 / EN 50067:1998.

Example: <02><00><02><52><41><44><49><4F><20><31><20>

Set PS in current data set for programme service 2 to >RADIO_1_<.

3.1.2 Message Name: PIN

Message Element Code: 06

Function: To set the PIN Code of the specified programme service on the specified data set(s).

Format:

	MSB	LSB
MEC	06	
DSN	00..FF	
PSN	00..FF	
MED	00..FD	PIN (MSB)
MED	00..FB	PIN (LSB)

Conventions: Coding of PIN is according to IEC EN 62106:2000 / EN 50067:1998.

Example: <06><00><06><71><5E>

Set PIN for day = 14, hour = 5, minute = 30 in current data set, for programme service 6.

3.1.3 Message Name: DI/PTYI

Message Element Code: 04

Function: To set the Decoder Information and dynamic PTY Indicator codes of the specified programme service(s) on the specified data set(s).

Format:

	MSB	LSB	
MEC	04		
DSN	00..FF		
PSN	00..FF		
MED	00..0F		Bit 0: mono/stereo Bit 1: artificial head no/yes Bit 2: compressed no/yes Bit 3: dynamic PTY Indicator

Conventions: Coding of DI/PTYI is according to IEC EN 62106:2000 / EN 50067:1998.

Example: <04><00><03><01>

Set DI/PTYI to stereophonic transmission (=1) in current data set, for programme service 3. Set also artificial head to “no”, compressed to “no” and dynamic PTYI to “static”.

3.1.4 Message Name: TA/TP

Message Element Code: 03

Function: To set the Traffic Announcement and Traffic Programme bits.

Format:

	MSB	LSB
MEC	03	
DSN	00..FF	
PSN	00..FF	
MED	00..03	

Bit 0: TA
Bit 1: TP

Conventions: Coding of TA and TP is according to IEC EN 62106:2000 / EN 50067:1998.

Example: <03><00><05><02>

Set on current data set TP = 1 and TA = 0, for programme service 5.

3.1.5 Message Name: MS**Message Element Code:** 05**Function:** To set the MS flag of the specified programme service on the specified data set(s).**Format:**

	MSB	LSB
MEC	05	
DSN	00..FF	
PSN	00..FF	
MED	00..01	

Bit 0: MS

Conventions: Coding of MS is according to IEC EN 62106:2000 / EN 50067:1998.**Example:** <05><00><01><01>

Set MS to 1 on current data set, for programme service 1.

3.1.6 Message Name: PTY

Message Element Code: 07

Function: To set the Programme Type information of the specified programme service on the specified data set(s).

Format:

	MSB	LSB
MEC	07	
DSN	00..FF	
PSN	00..FF	
MED	00..1F	

PTY

Conventions: Coding of PTY is according to IEC EN 62106:2000 / EN 50067:1998.

Example: <07><00><05><08>

Set PTY to 8 in current data set, programme service 5.

3.1.7 Message Name: PTYN

Message Element Code: 3E

Function: To set the Programme Type Name of the specified service(s) of the specified data set(s).

Format:

	MSB	LSB	
MEC	3E		
DSN	00..FF		
PSN	00..FF		
MED	20..FE		PTYN Character 1
MED	20..FE		PTYN Character 2
MED	20..FE		PTYN Character 3
MED	20..FE		PTYN Character 4
MED	20..FE		PTYN Character 5
MED	20..FE		PTYN Character 6
MED	20..FE		PTYN Character 7
MED	20..FE		PTYN Character 8

Conventions: Coding of PTYN is according to IEC EN 62106:2000 / EN 50067:1998.

Example: <3E><00><02><46><6F><6F><74><62><61><6C><6C>

Set PTYN in current data set for programme service 2 to >Football<.

3.1.8 Message Name: RT

Message Element Code: 0A

Function: To edit Radiotext.

Format:

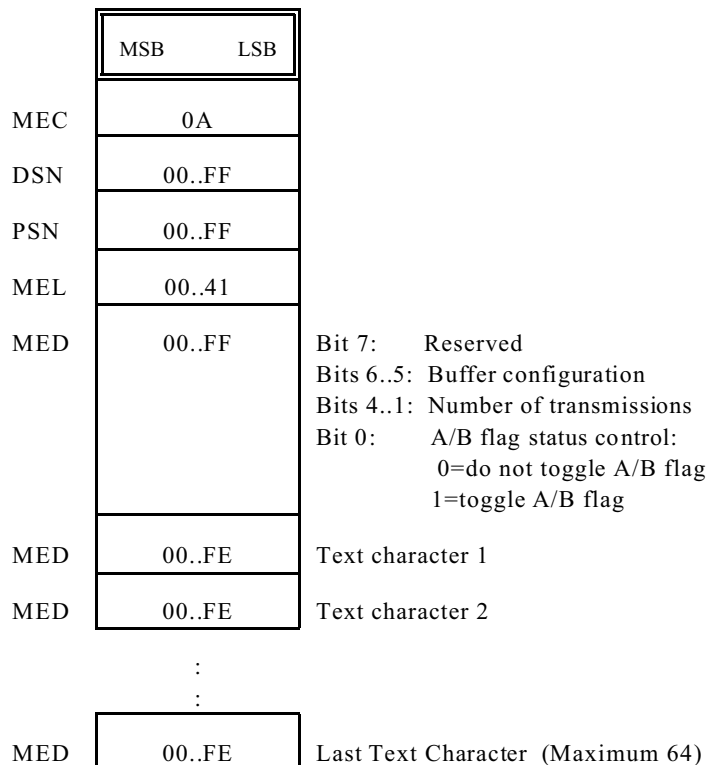

Conventions: Coding of Radiotext data is according to IEC EN 62106:2000 / EN 50067:1998.

If the buffer is empty then no Radiotext is transmitted.

If a message is received with MEL=0, then the buffer is emptied and therefore transmission ceases. This may also be achieved with MEL=1 with bits 5 and 6 of the MED=0.

If the buffer contains only one message, then transmission is repeated indefinitely, despite the defined number of transmissions. If further messages are added, then each message (including the first) is transmitted as defined by its number of transmissions field, within an overall indefinite cycle as shown below.

Cycle Diagram:

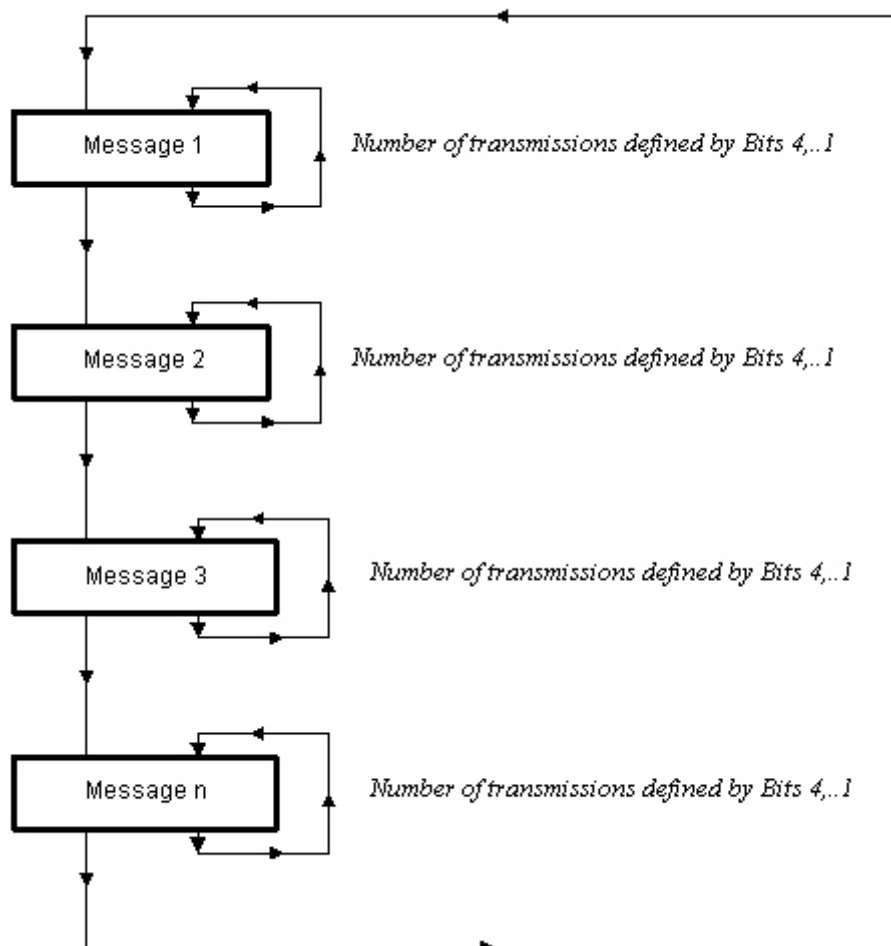

Bits 4..1: 0 Indefinite transmissions
 1 - F Hex value of the number of transmissions of each individual message

<u>Bit 6</u>	<u>Bit 5</u>	<u>Buffer Configuration</u>
0	0	The Radiotext buffer is completely flushed then, if MEL is greater than 1, the specified Radiotext message is placed in the buffer.
0	1	Reserved
1	0	Add specified Radiotext message to the Radiotext buffer. The Radiotext messages within the buffer are transmitted cyclically. Each message is repeated individually, within the cycle, a number of times as specified in Bits 4..1.
1	1	Reserved

Example: <0A><00><01><04><0B><52><44><53>

Send to current data set, programme service 1. This message causes the buffer to be flushed, the A/B flag to be toggled and the text >RDS< is transmitted indefinitely.

<0A><00><01><05><51><74><65><78><74>

Send to current data set, programme service 1. This, message adds another Radiotext message >text< to the buffer to be repeated 8 times. The previous message and this message are cycled. >RDS< is sent five times, then >text< 8 times and so on.

Request Message Command Format:

To request the Radiotext, the following format is required:

	MSB	LSB	
MEC	17		
MEL	04		
MED	0A		Code of requested message
MED	00..FF		DSN
MED	00..FF		PSN
MED	00..FF		Radiotext Buffer number

If the requested Radiotext buffer is empty, the MEL is set to zero in the reply and no data follows.

3.1.9 Message Name: AF

Message Element Code: 13

Function: To edit AF data in the specified data set(s) of the specified programme service(s).

Format:

	MSB	LSB	
MEC	13		
DSN	00..FF		
PSN	00..FF		
MEL	03..FB		
MED	00..FF		Start Location (High)
MED	00..FF		Start Location (Low)
MED	01..FF		AF Data
MED	01..FF		AF Data
	:		
	:		
MED	01..FF		AF Data
MED	00		Terminator, if necessary

Conventions: The PSN must be a main service in the addressed data set(s). An AF value of 00 indicates the end of the AF list(s) loaded into memory. The AF list terminator 00 indicates that the transmission of AF data has to restart from location 00 00 in the specified AF memory. The start location defines the offset in AF codes from the beginning of the AF memory used for the respective programme service, at which the new data is to be stored. If the start location is set to FF FF, then the AF data are appended at the location of the first terminator 00, of the specified AF memory. In this case the terminator is required in the supplied message.

In loading the AF codes into memory, no distinction is made between the different Methods A or B. The AF list(s) have to be structured in pairs as in IEC EN 62106:2000 / EN 50067:1998.

Example: <13><00><01><07><00><00><E2><15><27><CD><00>

AFs for current data set, programme service 1, offset by 0 AF codes, are set to frequency codes E2 15 27 CD (2 frequencies follow, 89.6 MHz, 91.4 MHz and the filler code).

Request Message Command Format:

To request the AF data, the following format is required:

	MSB	LSB	
MEC	17		
MEL	05		
MED	13		Code of requested message
MED	00..FF		DSN
MED	00..FF		PSN
MED	00..FF		Start location (high)
MED	00..FF		Start location (low)

3.1.10 Message Name: EON - AF

Message Element Code: 14

Function: To edit EON AF data on the specified data set(s) of the specified programme service(s).

Format:

	MSB	LSB	
MEC	14		
DSN	00..FF		
PSN	00..FF		
MEL	04..FB		
MED	00..FF		Start Location (High)
MED	00..FF		Start Location (Low)
MED	04..09		AF Data (Variant code of Group Type 14A)
MED	01..FF		AF Data
MED	01..FF		AF Data
	:		
	:		
MED	00		Terminator, if necessary

Conventions: AF data are prepared in three byte units for direct coding in type 14A groups. The first byte of each three designates the variant code in the range 4..9. An AF value of 00 terminates the AF list(s). The start location defines the offset in bytes (including the variant codes) from the beginning of the AF memory used for the respective programme service, at which the new data is to be stored. The EON AF list terminator 00 indicates that the transmission of AF data has to restart from location 00 00 in the specified EON AF memory. If the start location is set to FF FF, then the EON AF data are appended at the location of the first EON AF list terminator of the specified EON AF memory. In this case the terminator is required in the supplied message.

The specified programme service must be an EON service in all addressed data set(s). The EON AF lists have to conform to IEC EN 62106:2000 / EN 50067:1998.

Example:

<14><00><01><09><00><00><05><15><19><05><18><10><00>

In the current data set, programme service number 1, AF memory location offset by 0 AF codes, set two mapped frequencies with variant code 5, main frequency 89.6 MHz, mapped frequency 90.0 MHz, variant code 5, main frequency 89.9 MHz, mapped frequency 89.1 MHz

Request Message Command Format:

To request the EON - AF data, the following format is required:

	MSB	LSB	
MEC	17		
MEL	05		
MED	14		Code of requested message
MED	00..FF		DSN
MED	00..FF		PSN
MED	00..FF		Start location (high)
MED	00..FF		Start location (low)

3.1.11 Message Name: Slow labeling codes

Message Element Code: 1A

Function: To edit data for type 1A group, block 3.

Format:

	MSB	LSB	
MEC	1A		
DSN	00..FF		
MED	0..7 0..F		Bit 7: Reserved Bits 6..4: Variant code Bits 3..0: Data MSB
MED	00..FF		Data LSB

Conventions: For each Variant code 0..7, data can be set in the range 000..FFF.

Example: <1A><04><00><E2>

In data set number 4, set the data transmitted with Variant code 0 to 0E2 hex.

Request Message Command Format:

To request Slow Labelling Variant codes, the following format is required:

	MSB	LSB	
MEC	17		
MEL	03		
MED	1A		Code of requested message
MED	00..FF		DSN
MED	00..07		Variant Code

3.1.12 Message Name: Linkage information

Message Element Code: 2E

Function: To edit Linkage information, variant 12 of block 3 of type 14A groups. The Linkage activator LA (MSB) is also in type 1A group, block 3.

Format:

	MSB	LSB	
MEC	2E		
DSN	00..FF		
PSN	00..FF		
MED	00..FF		Link information MSB
MED	00..FF		Link information LSB

Conventions: The Linkage information is mapped as applied in type 14A groups.

If the PSN specified is the main PSN, the most significant bit (the Linkage Actuator LA) is sent in type 1A groups and the Linkage Set Number LSN is transmitted using a type 14A group in which the PI ON= PI TN.

Example: <2E><02><03><81><23>

Set Linkage information in data set 2, programme service 3, to 8123 hex. The Linkage Actuator is set to 1. If programme service 3 is the main PSN, the Linkage Actuator will be transmitted in type 1A and 14A groups with value 1.

3.1.13 Message Name: ODA Configuration and Short Message Command

Message Element Code: 40

Function: To set the ODA Application Group Type Code and AID, in type 3A groups. The command also edits the Type 3A group message bits in Block 3. The command also initialises (by disabling) ODA Data access rights on all ports for the configured AID (see MEC 47).

Format:

	MSB	LSB	
MEC	40		
MED	00..1B		Application Group Type code (see IEC EN 62106:2000 / EN 50067:1998, Table 6 for valid codes)
MED	00..FF		AID (MSB)
MED	00..FF		AID (LSB)
MED	00..03		Bits 1..0 Buffer configuration
MED	00..FF		Message (MSB)
MED	00..FF		Message (LSB)
MED	00..FF		ODA data input timeout, where: 0 = off and 1 - 255 minutes can be signalled

Conventions:

The available Application Group Type codes are defined in Table 6 of IEC EN 62106:2000 / EN 50067:1998. The Application Group Type code addresses the application, as only one group type per application is permitted. When configured for cyclic transmission, loss of application data input (to the encoder) for longer than the data input timeout, will be signalled by Type 3A groups of this AID with Application Group Type code set to 1F. An Application Group type code 00 is used to indicate that there is no associated group.

Bits 1 and 0 of the fourth MED are coded as follows:

<u>Bit 1</u>	<u>Bit 0</u>	<u>Buffer Configuration</u>
0	0	Information transmitted once only and removed after transmission
0	1	Reserved
1	0	For cyclic transmission, type 3A groups are added to the specified buffer
1	1	Remove all type 3A groups from the specified Application Group type buffer

Example:

<40><16><12><34><02><AB><CD><0A>

Assign Group Type code 11A to AID >1234< hex. The message >ABCD< hex is added to the buffer for cyclic transmission. The ODA data input timeout is set to 10 minutes.

Request Message Command Format:

To request the Application Group type code used for ODA configuration.

	MSB	LSB	
MEC	17		
MEL	01..02		
MED	40		Code of requested message
MED	00..0B		[Application Group type code]. If none specified, data for all Application Group type codes will be packed into separate message elements inside the same frame. But if this is too long for a single frame, then the Error message 09: "not acceptable" will be generated.

3.1.14 Message Name: ODA Identification Group usage sequence

Message Element Code: 41

Function: To set the ODA Identification Group usage sequence for type 3A groups, in the specified data set(s).

Format:

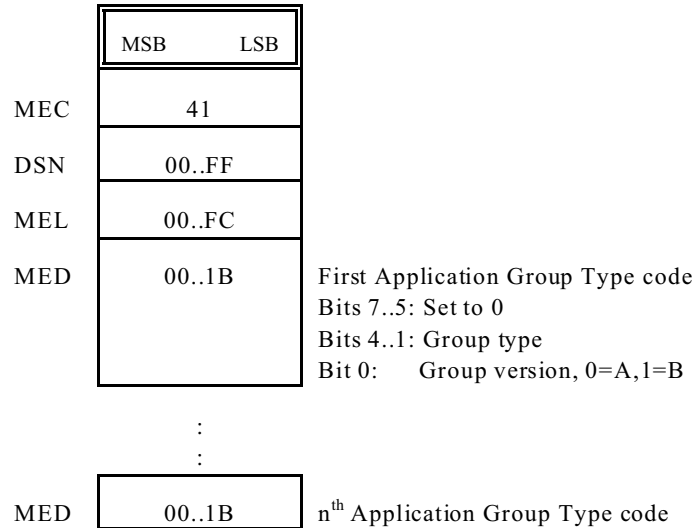

Conventions: The available Application Group Type codes are defined in Table 6 of IEC EN 62106:2000 / EN 50067:1998.

An Application Group Type code 00 is used to indicate Type 3A groups with no associated group.

Type 3A groups are transmitted according to the group sequence. Within the group sequence the Application Group Type code to be transmitted is determined by the usage sequence.

If no usage sequence is used, each programmed Application Group Type code is transmitted once.

Example: <41><00><04><16><16><16><12>

Set a new ODA Identification Group usage sequence in the current data set as: > 11A, 11A, 11A, 9A <. Therefore type 3A groups will be transmitted in the ratio 75% conveying type 11A group information and 25% conveying type 9A group information.

Request Message Command Format:

To request the ODA Identification Group usage sequence, the following format is required:

	MSB	LSB	
MEC	17		
MEL	02		
MED	41		Code of requested message
MED	00..FF		DSN

3.1.15 Message Name: ODA Free-format group (Message bits)⁴⁾**Message Element Code:** 42**Function:** To add a group to the free-format buffer for that Application Group Type Code.**Format:**

	MSB	LSB	
MEC	42		
MED	07..1B		Application Group Type code (see IEC EN 62106:2000 / EN 50067:1998, page 19 for valid codes)
MED	00..7F		Configuration: Bits 7..6: Set to 0 Bits 5 to 4: Priority setting (see 2.5.3) Bits 3..2: Mode selection Bits 1..0: Buffer configuration
MED	00..1F		Block 2, 5 bits
MED	00..FF		Block 3 MSB
MED	00..FF		Block 3 LSB
MED	00..FF		Block 4 MSB
MED	00..FF		Block 4 LSB

Conventions:

Bits 1 and 0 of the second MED are coded as follows:

<u>Bit 1</u>	<u>Bit 0</u>	<u>Buffer configuration</u>
0	0	Information transmitted once only and removed after transmission
0	1	Reserved
1	0	For cyclic transmission, free-format information sets are added to the specified buffer
1	1	Remove all free-format information sets from the specified free-format buffer

⁴⁾ New applications should use MEC 46 to associate ODA data to the AID rather than this MEC which associates data to Group type. Thus the use of MEC 46 allows data transmission to be separated from configuration commands.

Bits 3 and 2 of the second MED are coded as follows:

<u>Bit 3</u>	<u>Bit 2</u>	<u>Mode selection</u>
0	0	Normal mode
0	1	“Burst mode” (See MEC 44)
1	0	“Spinning wheel mode” (See MEC 45)
1	1	Reserved

Bits 5 and 4 of the second MED are coded as follows:

<u>Bit 5</u>	<u>Bit4</u>	<u>Priority setting (see 2.5.3)</u>	
0	0	Normal	} Valid only if the buffer configuration is 00.
0	1	“Extremely urgent”	
1	0	Immediate	
1	1	Reserved	

Bits 6 - 7 of the second MED are set to zero.

A group sent with “Extremely urgent” priority will be inserted as soon as possible according to the group sequence.

A group with “immediate” priority will be transmitted immediately, irrespective of group sequence, but respecting the priorities defined in the RDS standard IEC EN 62106:2000 / EN 50067:1998, unless the ODA priority group sequence has been configured (see 2.5.3 and 3.3.17).

Example:

<42><16><14><12><34><56><78><90>

Data for ODA Application Group Type code 11A, Block 2 data is 12hex, Block 3 data is 3456hex and Block 4 data is 7890hex. The data is transmitted once only in burst mode (defined by the ODA Control command MEC 44), with high priority.

3.1.16 Message Name: ODA Relative Priority Group Sequence

Message Element Code: 43

Function: To set the relative priority level for groups transmitted using the ODA free-format command with “immediate” priority (see 2.5.3).

Format:

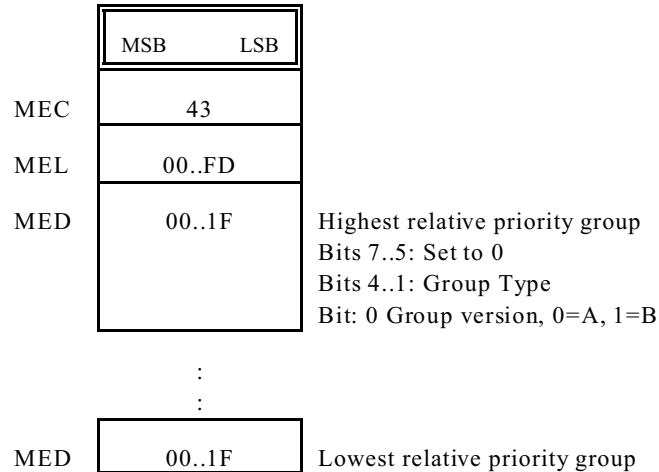

Conventions: If no ODA Relative Priority Group Sequence is specified, the priority of groups sent with the ODA free-format command and “immediate” priority is below the priorities specified in IEC EN 62106:2000 / EN 50067:1998.

Setting the ODA Relative Priority Group Sequence enables the relative priority of groups to be altered.

Example: <43><03><16><1F><1D>

Type 11A groups sent, using the ODA free-format command, will be given a higher priority for transmission than type 15B and type 14B groups generated by the encoder. Other high priority groups, such as type 4A groups or, in Paging mode, type 1A and type 13A groups will still have higher priority.

3.1.17 Message Name: ODA “Burst Mode” Control

Message Element Code: 44

Function: To control the generation of ODA free-format groups, configured for “Burst mode” transmission (see 2.5.3).

Format:

	MSB	LSB	
MEC	44		
MED	07..1B		Bits 4..0: Application Group type code
MED	00..FF		Bits 7..4: Number of repetitions Bits 3..0: Spacing

Conventions: The number of repetitions are indicated in the range 0 to F times (according to relative priority). Spacing is indicated by the minimum number of other groups between two ODA free-format groups with this Application Group Type code.

Example: <44><16><10>

Transmit two ODA free-format Application Group type codes 11A, with no groups in between (depending on the priority - see MEC 42 and 43).

Request Message Command Format:

To request the Application Group type code used for ODA “Burst Mode”.

	MSB	LSB	
MEC	17		
MEL	01 or 02		
MED	44		Code of requested message
MED	07..0B		[Application Group type code]. If none specified, data for all Application Group type codes will be packed into separate message elements inside the same frame. But if this is too long for a single frame, then the Error message: 09 “not acceptable” will be generated.

3.1.18 Message Name: ODA “Spinning Wheel” timing Control

Message Element Code: 45

Function: To set the timing parameters for ODA Application Group Type codes, configured for “Spinning Wheel” transmission (see 2.5.3).

Format:

	MSB	LSB	
MEC	45		
MED	07..1B		Application Group Type code (see IEC EN 62106:2000 / EN 50067:1998, Table 6 for valid codes)
MED	01..3C		Number of time slots
MED	00..3C		Window time (in seconds)
MED	00..3B		Delay time, relative to beginning of the minute (in seconds).

Conventions: The number of time slots should be chosen to give an integer number of seconds.

The time from the beginning of the time slot until the beginning of the window time, is the “active time” during which the ODA Application Group Type codes may be transmitted.

Example: <45><16><0A><03><00>

Sets 10 time slots of 3 seconds “active time” and 3 seconds “window time”, for the ODA Application Group Type 11A, synchronized to the beginning of the minute.

Request Message Command Format:

To request the Application Group type code used for ODA “Spinning Wheel Mode”.

	MSB	LSB	
MEC	17		
MEL	01 or 02		
MED	45		Code of requested message
MED	07..0B		[Application Group type code]. If none specified, data for all Application Group type codes will be packed into separate message elements inside the same frame. But if this is too long for a single frame, then the Error message: 09 “not acceptable” will be generated.

3.1.19 Message Name: ODA Data command

Message Element Code: 46

Function: To transmit ODA data.

Format:

	MSB	LSB	
MEC	46		
MEL	05		
MED	00..FF		AID MSB
MED	00..FF		AID LSB
MED	40..43		Configuration: Bit 7: Set to 0 Bit 6: 1, Short message flag Bits 5..2: Set to 0 Bits 1..0: Buffer configuration
MED	00..FF		Message (MSB)
MED	00..FF		Message (LSB)

or

	MSB	LSB	
MEC	46		
MEL	06 or 08		08: If Group type A 06: If Group type B
MED	00..FF		AID MSB
MED	00..FF		AID LSB
MED	00..3F		Configuration: Bit 7: Set to 0 Bit 6: 0, Short message flag Bits 5..4: Priority setting (see 2.5.3) Bits 3..2: Mode selection Bits 1..0: Buffer configuration
MED	00..1F		ODA data, Block 2, 5 bits
MED	00..FF		ODA data, Block 3 MSB (Group type A only)
MED	00..FF		ODA data, Block 3 LSB (Group type A only)
MED	00..FF		ODA data, Block 4 MSB
MED	00..FF		ODA data, Block 4 LSB

Conventions:

Bits 1 and 0 of the third MED are coded as follows:

<u>Bit 1</u>	<u>Bit 0</u>	<u>Buffer configuration</u>
0	0	Information transmitted once only and removed after transmission
0	1	Reserved
1	0	For cyclic transmission, free-format information sets are added to the specified buffer
1	1	Remove all free-format information sets from the specified free-format buffer

Bits 3 and 2 of the third MED are coded as follows:

<u>Bit 3</u>	<u>Bit 2</u>	<u>Mode selection</u>
0	0	Normal mode
0	1	“Burst mode” (See MEC 44)
1	0	“Spinning wheel mode” (See MEC 45)
1	1	Reserved

Bits 5 and 4 of the third MED are coded as follows:

<u>Bit 5</u>	<u>Bit 4</u>	<u>Priority setting</u> (see 2.5.3)
0	0	Normal
0	1	“Extremely urgent”
1	0	Immediate
1	1	Reserved

} Valid only if the buffer configuration is 00.

A group sent with “Extremely urgent” priority will be inserted as soon as possible according to the group sequence.

A group with “immediate” priority will be transmitted immediately, irrespective of group sequence, but respecting the priorities defined in the RDS standard IEC EN 62106:2000 / EN 50067:1998, unless the ODA priority group sequence has been configured (see 2.5.3 and 3.3.17).

Bit 6 of the third MED is coded as follows:

<u>Bit 6</u>	<u>Short message flag</u>
0	Data for associated ODA Group type
1	Data for Group type 3A (ODA short message)

Bit 7 of the third MED is set to zero.

Example:

<46><05><01><23><40><55><AA>

Transmit >55,AA< once only as short message data, in Group type 3A, for ODA-AID 0123

<46><08><01><23><00><1F><64><73><82><91>

Transmit >1F,64,73,82,91< once only as ODA free format data in normal mode and with normal priority in the Group type associated to ODA-AID 0123

3.1.20 Message Name: ODA Data command access right

Message Element Code: 47

Function: To enable or disable access to the ODA Data command on any port.

Format:

	MSB	LSB	
MEC	47		
MED	00..FF		AID (MSB)
MED	00..FF		AID (LSB)
MED	00..FF		0 = Current port 1 to 253 = Specific port 254 = All ports except current port 255 = All ports
MED	00..01		Bits 7..1: Set to zero Bit 0: Enable bit 0 = disabled 1 = enabled

Conventions: If a wrong or non-existent port number is specified, the encoder should respond with the Error message 06: "parameter out of range".

AID FFFF is used to configure access rights for all currently configured AIDs.

Example: <47><12><34><02><01>

ODA Data command access right is enabled for AID >1234< on port 2.

Request Message Command Format:

To request the ODA Data command access setting, the following format is required:

	MSB	LSB	
MEC	17		
MEL	02		
MED	47		Code of requested message
MED	01..FF		[Port number]. If 0 is specified, then the error message 06 will be generated: "parameter out of range".

Conventions: Data for all configured AIDs are packed into separate message elements in the same frame.

3.1.21 Message Name: TDC

Message Element Code: 26

Function: To edit the data for the Transparent Data Channel.

Format:

		MSB	LSB	
MEC		26		
MEL		02..FD		
MED		00..01		00 = Group Version A 01 = Group Version B
MED		00..7F		Bit 7: Set to 0 (Reserved) Bits 6..5: Buffer Configuration Bits 4..0: Channel number as in IEC EN 62106:2000 / EN 50067:1998
MED		00..FF		Data
MED		00..FF		Data
		:		
		:		
MED		00..FF		Data

Conventions: The data in the command are sent together with the given binary coded channel number.

The data must be provided in multiples of 4 bytes for A groups and 2 bytes for B groups

Bits 6 and 5 of the second Message Element Data are coded as follows:

<u>Bit 6</u>	<u>Bit 5</u>	<u>Buffer Configuration</u>
0	0	Information transmitted once only and removed after transmission
0	1	Remove the TDC information sets from the specified TDC channel of the TDC buffer
1	0	For cyclic transmission, TDC information sets are added to the specified TDC buffer
1	1	Remove all TDC information sets from the specified TDC buffer

Example: <26><06><00><01><45><42><55><20>

Send the data >EBU_< on TDC channel 1, once only.

3.1.22 Message Name: EWS

Message Element Code: 2B

Function: Edit the Emergency Warning System data (37 bits) in type 9A group.

Format:

	MSB	LSB	
MEC	2B		
MED	00..7F		Bit 7: Set to 0 (Reserved) Bits 6..5: Buffer Configuration Bits 4..0: Block 2, 5 Bits
MED	00..FF		Block 3 MSB
MED	00..FF		Block 3 LSB
MED	00..FF		Block 4 MSB
MED	00..FF		Block 4 LSB

Conventions: 37 bits of EWS data are to be sent to the encoder EWS buffer.

Bits 6 and 5 of the first Message Element Data are coded as follows:

<u>Bit 6</u>	<u>Bit 5</u>	<u>Buffer Configuration</u>
0	0	Information transmitted once only and removed after transmission
0	1	Reserved
1	0	For cyclic transmission, EWS information sets (37 bits) are added to the buffer
1	1	Remove all EWS information sets (37 bits) from the EWS buffer

Example: <2B><41><23><45><67><89>

Add the EWS data >01 2345 6789< hex for type 9A group to the EWS buffer. Transmit the contents of the buffer including this new information cyclically.

3.1.23 Message Name: IH

Message Element Code: 25

Function: To edit the In-house applications and specify the group version.

Format:

	MSB	LSB	
MEC	25		
MED	00..01		00 = Group Version A 01 = Group Version B
MED	00..7F		Bit 7: Set to 0 Bits 6..5: Buffer Configuration Bits 4..0: Block 2, 5 Bits
MED	00..FF		Block 3 MSB
MED	00..FF		Block 3 LSB
MED	00..FF		Block 4 MSB
MED	00..FF		Block 4 LSB

Conventions: The data in type 6A or 6B groups block 2, 3, and 4 are sent as 10 hex numbers.

In the case of type B groups, the information for block 3 will be overridden by the information of the PI code.

Bits 6 and 5 of the second Message Element Data are coded as follows:

<u>Bit 6</u>	<u>Bit 5</u>	<u>Buffer Configuration</u>
0	0	Information transmitted once only and removed after transmission
0	1	Reserved
1	0	For cyclic transmission, IH information sets are added to the specified buffer
1	1	Remove all IH information sets from the specified IH buffer

Example: <25><01><60><00><00><00><00>

Remove all IH information from the specified IH buffer B.

3.1.24 Message Name: TMC⁵⁾

Message Element Code: 30

Function: Edit the TMC data in type 8A group.

Format:

	MSB	LSB	
MEC	30		
MEL	01..FB		
MED	00..FF		Bit 7: 0= Normal, 1= "Extremely Urgent" Bits 6..5: Buffer Configuration Bits 4..1: Number of transmissions 1-15 Bit 0: Set to zero
MED	00..1F		Block 2 5 bits of first TMC message
MED	00..FF		Block 3 MSB of first TMC message
MED	00..FF		Block 3 LSB of first TMC message
MED	00..FF		Block 4 MSB of first TMC message
MED	00..FF		Block 4 LSB of first TMC message
	:		
	:		
MED	00..FF		Block 4 LSB of nth TMC message

Conventions:

Multiples of 37 bits of TMC data are to be sent to the encoder's internal TMC buffer. Bits 6 and 5 of the first Message Element Data are coded as follows:

<u>Bit 6</u>	<u>Bit 5</u>	<u>Buffer Configuration</u>
0	0	Information transmitted with the number of transmissions specified and removed after completion
0	1	Reserved
1	0	For cyclic transmission, TMC information sets (37 bits) are added to the TMC buffer
1	1	Remove all TMC information sets from the TMC buffer

Example:

<30><0B><04><01><23><65><B0><E3><11><23><45><67><89>

Add the TMC data, >01 2365 B0E3< and >11 2345 6789< hex, with normal priority to the TMC buffer. Transmit each information set twice.

⁵⁾ It is recommended in CEN ENV/12313-1 that TMC be transmitted in ODA using type 8A/3A groups. Therefore ODA commands should be used (see MECs 40 to 47).

3.1.25 Message Name: Free-format group

Message Element Code: 24

Function: To add a group to the free-format buffer for that group type.

Format:

	MSB	LSB	
MEC	24		
MED	00..1F		Bits 4..1: Group Type number Bits 0: Group Version A or B
MED	00..7F		Bit 7: Set to 0 Bits 6..5: Buffer Configuration Bits 4..0: Block 2, 5 Bits
MED	00..FF		Block 3 (MSB)
MED	00..FF		Block 3 (LSB)
MED	00..FF		Block 4 (MSB)
MED	00..FF		Block 4 (LSB)

Conventions:

If free-format data is present in the buffer for the scheduled group, it will be transmitted instead of the "internally generated RDS data". An encoder schedules group transmission according to its group sequence or higher priority event. If free-format data is present in the buffer for a group type which is not scheduled for transmission the free-format data will not be transmitted. Therefore the necessary group for free-format data has to be inserted into the group sequence in addition to the "normal RDS groups".

Bits 6 and 5 of the second MED are coded as follows:

<u>Bit 6</u>	<u>Bit 5</u>	<u>Buffer Configuration</u>
0	0	Information transmitted once only and removed after transmission
0	1	Reserved
1	0	For cyclic transmission, free-format information sets are added to the specified buffer
1	1	Remove all free-format information sets from the specified free-format buffer

Example:

<24><07><0C><00><00><AB><DE>

Data for type 3B group, Block 2 data is 0C hex, Block 3 data will be overwritten by PI code because type B group is selected, Block 4 data is AB DE hex. The data is transmitted only once.

3.1.26 Message Name: Paging call without message**Message Element Code:** 0C**Function:** To send a paging call with no message and specify the number of repetitions.**Format:**

	MSB	LSB	
MEC	0C		
MED	0..F	0..F	Bits 7..4: Number of repetitions (max 15) Bits 3..0: Pager address (MSB)
MED	00..FF		Pager address
MED	00..FF		Pager address (LSB)

Conventions:

The first hex number (bits 7..4) of the first byte of the Message Element Data (MED) is used to define the number of repetitions of a paging call. If this number equals 0, the default repetition number shall be used. The second hex number (bits 3..0) of the first byte of the MED and the next two bytes of the MED, represent 20 bits for hex coding of the pager address number (a number of 6 digits) as in IEC EN 62106:2000 / EN 50067:1998.

Example:

<0C><20><25><34>

Send a call, twice, to pager address "009524" (02534 hex).

3.1.27 Message Name: **Paging call with numeric message (10 digits)**

Message Element Code: 08

Function: To send a paging call with a 10 digit numeric message and specify the number of repetitions.

Format:

	MSB	LSB	
MEC	08		
MED	0..F	0..F	Bits 7..4: Number of repetitions (max 15) Bits 3..0: Pager address (MSB)
MED	00..FF		Bits 7..0: Pager address
MED	00..FF		Bits 7..0: Pager address (LSB)
MED	0..A	0..A	Message (first 2 digits)
MED	0..A	0..A	Message (second 2 digits)
MED	0..A	0..A	Message (third 2 digits)
MED	0..A	0..A	Message (fourth 2 digits)
MED	0..A	0..A	Message (fifth 2 digits)

Conventions: The first hex number (bits 7..4) of the first byte of the Message Element Data (MED) is used to define the number of repetitions of a paging call. If this number equals 0, the default repetition number shall be used. The second hex number (bits 3..0) of the first byte of the MED and the next two bytes of the MED, represent 20 bits for hex coding of the pager address (6 digits). The remainder of the MED contains the 10 digit message, in conformity with IEC EN 62106:2000 / EN 50067:1998.

Example: <08><31><84><86><72><10><01><1A><AA>

Send the message >7210011 _ _ _<, three times, to pager address "099462" (18486 hex).

3.1.28 Message Name: **Paging call with numeric message (18 digits)**

Message Element Code: 20

Function: To send a paging call with an 18 digit numeric message and specify the number of repetitions.

Format:

	MSB	LSB	
MEC	20		
MED	0..F	0..F	Bits 7..4: Number of repetitions Bits 3..0: Pager address (MSB)
MED	00..FF		Bits 7..0: Pager address
MED	00..FF		Bits 7..0: Pager address (LSB)
MED	0..A 0..A		Message (first 2 digits)
MED	0..A 0..A		Message (second 2 digits)
MED	0..A 0..A		Message (third 2 digits)
	:		
	:		
MED	0..A 0..A		Message (eighth 2 digits)
MED	0..A 0..A		Message (last 2 digits)

Conventions: The first hex number (bits 7..4) of the first byte of the Message Element Data (MED) is used to define the number of repetitions of a paging call. If this number equals 0, the default repetition number shall be used. The second hex number (bits 3..0) of the first byte of the MED and the next two bytes of the MED, represent 20 bits for hex coding of the pager address (6 digits). The remainder of the MED contains the 18 digit message, in conformity with IEC EN 62106:2000 / EN 50067:1998.

Example: <20><F1><84><80><72><10><01><10><03><31><83><95><72>

Send the message >721001100331839572<, 15 times, to pager address "099456" (18480 hex).

3.1.29 Message Name: Paging call with alphanumeric message (80 characters)

Message Element Code: 1B

Function: To send a paging call with up to an 80 character alphanumeric message and specify the number of repetitions.

Format:

	MSB	LSB	
MEC	1B		
MEL	04..53		Message element length
MED	0..F 0..F		Bits 7..4: Number of repetitions Bits 3..0: Pager address (MSB)
MED	00..FF		Bits 7..0: Pager address
MED	00..FF		Bits 7..0: Pager address (LSB)
MED	00..FE		Message (first character)
MED	00..FE		Message (second character)
MED	00..FE		Message (third character)
	:		
	:		
MED	00..FE		Message (last character) Maximum of 80 characters

Conventions: The first hex number (bits 7..4) of the first byte of the Message Element Data (MED) is used to define the number of repetitions of a paging call. If this number equals 0, the default repetition number shall be used. The second hex number (bits 3..0) of the first byte of the MED and the next two bytes of the MED, represent 20 bits for hex coding of the pager address (6 digits). The remainder of the MED contains the alphanumeric message, in conformity with IEC EN 62106:2000 / EN 50067:1998.

Example: <1B><08><41><E2><40><48><65><6C><6C><6F>

Send the message >Hello< (1E240 hex), 4 times, to pager address "123456".

3.1.30 Message Name: International paging call with numeric message (15 digits)

Message Element Code: 11

Function: To send an International paging call with a 15 digit numeric message and specify the number of repetitions.

Format:

	MSB	LSB	
MEC	11		
MED	0..F	0..F	Bits 7..4: Number of repetitions (max 15) Bits 3..0: Pager address (MSB)
MED	00..FF		Bits 7..0: Pager address
MED	00..FF		Bits 7..0: Pager address (LSB)
MED	0..9 0..9		Country Code (2 digits)
MED	0..9	0..A	Bits 7..4: Country code (1 digit) Bits 3..0: Message (first 2 digits)
MED	0..A 0..A		Message (next 2 digits)
	:		
	:		
MED	0..A 0..A		Message (last 2 digits)

Conventions: The first hex number (bits 7..4) of the first byte of the Message Element Data (MED) is used to define the number of repetitions of a paging call. If this number equals 0, the default repetition number shall be used. The second hex number (bits 3..0) of the first byte of the MED and the next two bytes of the MED, represent 20 bits for hex coding of the pager address (6 digits). The remainder of the MED contains the 15 digit coded in conformity with IEC EN 62106:2000 / EN 50067:1998.

Example: <11><31><E2><40><22><00><03><8A><61><A3><01><92><6A>

Send the message >0038 61 301926<, 3 times, to pager address "123456" (1E240 hex) in country >220<.

3.1.31 Message Name: International paging with functions message

Message Element Code: 10

Function: To send a paging call with a international function message.

Format:

	MSB	LSB	
MEC	10		
MED	0..F	0..F	Bits 7..4: Number of repetitions (max 15) Bits 3..0: Pager address (MSB)
MED	00..FF		Bits 7..0: Pager address
MED	00..FF		Bits 7..0: Pager address (LSB)
MED	0..9	0..9	Country code (2 digits)
MED	0..9	0..F	Bits 7..4: Country code (1 digit) Bits 3..0: Message (first character)
MED	0..F	0..F	Message (second and third characters)
MED	0..F	0..F	Message (fourth and fifth characters)
MED	0..F	0..F	Message (sixth and seventh characters)

Conventions:

The first hex number (bits 7..4) of the first byte of the Message Element Data (MED) is used to define the number of repetitions of a paging call. If this number equals 0, the default repetition number shall be used. The second hex number (bits 3..0) of the first byte of the MED and the next two bytes of the MED, represent 20 bits for hex coding of the pager address (6 digits). The remainder of the MED contains the seven hex character message, in conformity with IEC EN 62106:2000 / EN 50067:1998.

Example:

<10><31><E2><40><78><9A><BC><DE><F0>

Send the function message >ABCDEF0<, three times, to pager "123456" (1E240 hex) in country >789<.

3.1.32 Message Name: Transmitter network group designation**Message Element Code:** 12**Function:** To set the transmitter network group designation.**Format:**

	MSB	LSB
MEC	12	
DSN	00..FF	
MED	00..07	

Conventions: Transmitter network group designation coding is in conformity with IEC EN 62106 / EN 50067:1998 (Section 3.2.6.2.2).

All information sets in the paging buffer are removed.

Example: <12><02><03>

Set the transmitter network group designation to >3< (Group code 40-99) in data set 2.

3.1.33 Message Name: EPP transmitter information

Message Element Code: 31

Function: To set paging area code, operator code, extended country code and notification method.

Format:

	MSB	LSB	
MEC	31		
DSN	00..FF		
MED	00..FF		Extended Country Code (ECC)
MED	00..3F		Paging Area Code (PAC)
MED	00..0F		Operator Code (OPC)
MED	00..FF		Current Carrier Frequency (CCF)
MED	00..07		Bit 0 : address notification bits, 0=25, 1=50 Bit 1: cycle structure, 0=60 s only, 1= mixed 60 s and 120 s Bit 2: 0=unsorted, 1= sorted

Conventions: The ECC is as defined in IEC EN 62106:2000 / EN 50067:1998. The PAC, OPC and CCF are as defined in IEC EN 62106:2000 / EN 50067:1998, Annex M. Bits 0,1 and 2 of the last MED refer respectively to the fields STY, CS and S1 S2, also defined in IEC EN 62106:2000 / EN 50067:1998, Annex M.

When the messages are sorted (Bit 2=1) it is recommended that ascending and descending sorting order be alternated.

Example: <31><00><E1><01><03><15><06>

Sets the ECC to E1, PAC to 01, OPC to 03 in the current data set, indicates a current carrier frequency 89.6 MHz, enables one type 13A group at the start of each paging interval; the paging cycle is mixed 60 seconds and 120 seconds and the paging messages are sorted.

3.1.34 Message Name: EPP call without additional message

Message Element Code: 32

Function: To send a paging call without additional message using EPP.

Format:

	MSB	LSB	
MEC	32		
MED	00..1F		Bit 6: priority, 0=normal, 1=high Bit 5: cycle structure, 0=60 s, 1=120 s Bit 4: 0=original call, 1=repetition Bits 3..0: paging call counter
MED	00..FF		Bits 7..0: pager address (group code)
MED	00..FF		Bits 7..0: pager address (individual code MSB)
MED	00..F9		Bits 7..0: pager address (individual code LSB)

Conventions:

The first byte of the MED indicates to the encoder that the message should be sent with high priority where the encoder structure allows this (Bit 6=1) or with normal priority (Bit 6=0), that the message is addressed to a paging receiver which runs on a 60 or 120 seconds cycle (Bit 5), that the message is the original call or a repetition generated by the paging server (Bit 4).

The paging call counter (Bits 3 to 0) and the repetition flag (Bit 4) are as defined in IEC EN 62106:2000 / EN 50067:1998, Annex M. The next three bytes of the MED represent the six digits of the pager address number coded in hexadecimal, but the sixth digit may not exceed 9 to respect the number of paging intervals.

Example:

<32><61><AB><CD><E6>

Sends a first paging call without additional message with high priority to the paging receiver address "ABCDE6" which follows a 120 seconds cycle. The paging call counter is 1.

3.1.35 Message Name: **EPP national and international call with alphanumeric message**

Message Element Code: 33

Function: To send an alphanumeric message paging call using EPP. Recommended maximum length is 80 characters.

Format:

		MSB	LSB	
MEC		33		
MEL		05..FD		
MED		00..FF		Bit 7: 0= national call, 1= international call Bit 6: call priority, 0=normal, 1=high Bit 5: cycle structure, 0=60 s, 1= 120 s Bit 4: 0=original call, 1=repetition Bits 3..0: paging call counter
MED		00..FF		Bits 7..0: country code (MSB), international call only
MED		00..FF		Bits 7..4: country code (LSB) , international call only Bits 3..0: original operator code, international call only
MED		00..FF		Bits 7..0: pager address (group code)
MED		00..FF		Bits 7..0: pager address (individual code MSB)
MED		00..F9		Bits 7..0: pager address (individual code LSB)
MED		00..FE		message (first character)
		:		
		:		
MED		00..FE		message (last character)

Conventions: The first byte of the MED indicates that the message is a national or international call (Bit 7), indicates to the encoder that the message should be sent with high priority where the encoder structure allows this (Bit 6=1) or with normal priority (Bit 6=0), that the message is addressed to a paging receiver which runs on a 60 or 120 seconds cycle (Bit 5), that the message is the original call or a repetition generated by the paging server (Bit 4).

The paging call counter (Bits 3 to 0) and the repetition flag (Bit 4) are as defined in IEC EN 62106:2000 / EN 50067:1998, Annex M.

The next two bytes of the MED are present only in the case of an international call and contain a country code (according to CCITT Rec. 212) and the original operator code according to RDS Paging WG Doc. 1 and 2. The next three bytes of the MED represent the six digits of a pager address number coded in hexadecimal but the sixth digit may not exceed 9 to respect the number of paging intervals. The following bytes contain the characters of the message.

Example:

<33><09><31><01><23><45><48><65><6C><6C><6F>

Sends a repeat of a national variable length alphanumeric message "hello" with normal priority to the paging receiver address "012345" which follows a 120 s cycle. The paging call counter is 1.

3.1.36 Message Name: EPP national and international call with variable length numeric message

Message Element Code: 34

Function: To send a numeric message paging call using EPP. Recommended maximum length is 160 digits.

Format:

	MSB	LSB	
MEC	34		
MEL	05..FD		
MED	00..FF		Bit 7: 0= national call, 1= international call Bit 6: call priority, 0=normal, 1=high Bit 5: cycle structure, 0=60 s, 1= 120 s Bit 4: 0=original call, 1=repetition Bits 3..0: paging call counter
MED	00..FF		Bits 7..0: country code (MSB), international call only
MED	00..FF		Bits 7..4: country code (LSB), international call only Bits 3..0: original operator code, international call only
MED	00..FF		Bits 7..0: pager address (group code)
MED	00..FF		Bits 7..0: pager address (individual code MSB)
MED	00..F9		Bits 7..0: pager address (individual code LSB)
MED	00..FF		message (first 2 digits)
	:		
	:		
MED	00..FF		message (last 2 digits)

Conventions: The first byte of the MED indicates that the message is a national or international call (Bit 7), indicates to the encoder that the message should be sent with high priority where the encoder structure allows this (Bit 6=1) or with normal priority (Bit 6=0), that the message is addressed to a paging receiver which runs on a 60 or 120 seconds cycle (Bit 5), that the message is the original call or a repetition generated by the paging server (Bit 4).

The paging call counter (Bits 3 to 0) and the repetition flag (Bit 4) are as defined in IEC EN 62106:2000 / EN 50067:1998, Annex M.

The next two bytes of the MED are present only in the case of an international call and contain a country code (according to CCITT Rec. 212) and the original operator code according to RDS Paging WG Doc. 1 and 2. The next three bytes of the MED represent the six digits of a pager address number coded in hexadecimal but the sixth digit may not exceed 9 to respect the number of paging intervals. The following bytes contain the digits of the message.

Example:

<34><05><26><EF><09><52><67>

Sends the first occurrence of a two digit long national variable length numeric message "67" with normal priority to the paging receiver address "EF0952" which follows a 120 second cycle. The value of the paging call counter is 6.

3.1.37 Message Name: EPP national and international call with variable length functions message

Message Element Code: 35

Function: To send a functions message paging call using EPP. Recommended maximum length is 160 digits.

Format:

	MSB	LSB	
MEC	35		
MEL	05..FF		
MED	00..FF		Bit 7: 0= national call, 1= international call Bit 6: call priority, 0=normal, 1=high Bit 5: cycle structure, 0=60 s, 1= 120 s Bit 4: 0=original call, 1=repetition Bits 3..0: paging call counter
MED	00..FF		Bits 7..0: country code (MSB), international call only
MED	00..FF		Bits 7..4: country code (LSB), international call only Bits 3..0: original operator code, international call only
MED	00..FF		Bits 7..0: pager address (group code)
MED	00..FF		Bits 7..0: pager address (individual code MSB)
MED	00..F9		Bits 7..0: pager address (individual code LSB)
MED	00..FF		message (first 2 digits)
	:		
	:		
MED	00..FF		message (last 2 digits)

Conventions: The first byte of the MED indicates that the message is a national or international call (Bit 7), indicates to the encoder that the message should be sent with high priority where the encoder structure allows this (Bit 6=1) or with normal priority (Bit 6=0), that the message is addressed to a paging receiver which runs on a 60 or 120 seconds cycle (Bit 5), that the message is the original call or a repetition generated by the paging server (Bit 4).

The paging call counter (Bits 3 to 0) and the repetition flag (Bit 4) are as defined in IEC EN 62106:2000 / EN 50067:1998, Annex M.

The next two bytes of the MED are present only in the case of an international call and contain a country code (according to CCITT Rec. 212) and the original operator code according to RDS Paging WG doc. 1 and 2. The next three bytes of the MED represent the six digits of a pager address number coded in hexadecimal but the sixth digit may not exceed 9 to respect the number of paging intervals. The following bytes contain the digits of the message.

Example:

<35><08><D3><20><83><C4><8F><91><12><34>

Sends a repetition of a four digit long international variable length functions message "1234" with high priority to the paging receiver address "C48F91" which follows a 60 s cycle. The value of the paging call counter is 3. The CCITT code is 208, and the original OPC is 3.

3.1.38 Message Name: Real time clock

Message Element Code: 0D

Function: To set the date and time.

Format:

	MSB	LSB	
MEC	0D		
MED	00..63		Last two decimal digits of Year expressed as hex
MED	00..0C		Month
MED	00..1F		Date
MED	00..17		Hours
MED	00..3B		Minutes
MED	00..3B		Seconds
MED	00..63		Centiseconds
MED	00..FF		00...3F: Local Time offset FF= Local Time offset unchanged 40...FE: undefined

Conventions:

Time of day is expressed in terms of Co-ordinated Universal Time (UTC).

The local Time Offset byte should be coded in conformity with IEC EN 62106:2000 / EN 50067:1998, as follows:

MSB				LSB				
1	2	3	4	5	6	7	8	
Not Used	Not Used	Sign of Local Time Offset	Magnitude of Local Time Offset in multiples of half hours					
		0 = +						
		1 = -						

Date, hours, minutes, seconds and centiseconds are coded as binary numbers and then expressed as a two digit hex number. If all fields are set to zero, the type 4A groups are transmitted with all zeros.

Example:

<0D><02><09><0C><0A><12><21><0F><02>

The following is to be set: Year is 2002, Month is September, Date is 12, Hour is 10, Minute is 18, Second is 33, Centisecond is 15 and Local Time offset is 1 hour.

3.1.39 Message Name: Real time clock correction**Message Element Code:** 09**Function:** To set real time clock correction (RTCC) in order to compensate a delay caused by the signal distribution. The adjustment range is between -32768 ms and +32767 ms.**Format:**

	MSB	LSB	
MEC	09		
MED	00..FF		RTCC higher byte hex
MED	00..FF		RTCC lower byte hex

Conventions: The RTCC is coded as a 16 Bit two's complement number.**Example:** <09><FF><C6>

Set Real Time Clock Correction to -58ms.

3.1.40 Message Name: CT On/Off

Message Element Code: 19

Function: To enable/disable the transmission of type 4A group.

Format:

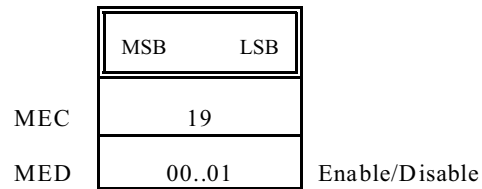

Conventions: "01" enables the transmission of type 4A groups and "00" disables it. The time is set with the Real Time Clock Command.

Example: <19><01>

Enable transmission of type 4A group.

3.1.41 Message Name: **RDS On/Off**

Message Element Code: 1E

Function: To switch RDS output signal "On" or "Off".

Format:

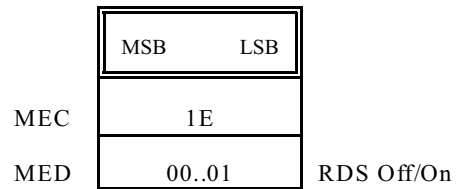

Conventions: "00" switches RDS "Off", "01" switches "On"

Example: <1E><00>

Switch the RDS output signal "Off".

3.1.42 Message Name: RDS phase

Message Element Code: 22

Function: To set RDS subcarrier phase shift relative to the phase of the 3rd harmonic of the 19 kHz reference signal for a specified Reference Table entry.

Format:

	MSB	LSB	
MEC	22		
MED	0..7 0..E		Bits 7..5: Reference Table entry Bit 4: Set to 0 Bits 3..0: RDS phase MSB
MED	00..FF		RDS phase LSB

Conventions: Reference '0' means that the phase is related to all table entries, '1' to '6' identify a specific table entry, '7' is the currently selected table entry. The RDS phase is expressed in the range from 0 to 359.9 degrees, in steps of 0.1 degrees and converted to a hex number.

Example: <22><45><4C>

Set phase to 135.6 degrees for Reference Table entry: Input 4.

Request Message Command Format:

To request the RDS phase, the following format is required:

	MSB	LSB	
MEC	17		
MEL	02		
MED	22		Code of requested message
MED	00..07		Reference table entry

On a request, with reference table entry set to 0, the data of all reference table entries is returned in separate message elements.

3.1.43 Message Name: RDS level

Message Element Code: 0E

Function: To adjust the level of the RDS subcarrier in mV_{p-p} for a specified Reference Table entry.

Format:

	MSB	LSB	
MEC	0E		
MED	0..7	0..1F	Bits 7..5: Reference Table entry Bits 4..0: RDS level MSB
MED	00..FF		RDS level LSB

Conventions: Reference "0" means that the level is related to all table entries, "1" to "6" identify a specific table entry, "7" is the currently selected table entry. The RDS level is expressed in the range from 0 to 8191 mV_{p-p} , and converted to a 13 Bit number.

Example: <0E><A3><11>

Set RDS level to 785 mV_{p-p} for Reference Table entry: input 5.

Request Message Command Format:

To request the RDS level, the following format is required:

	MSB	LSB	
MEC	17		
MEL	02		
MED	0E		Code of requested message
MED	00..07		Reference table entry

On a request, with reference table entry set to 0, the data of all reference table entries is returned in separate message elements.

3.1.44 Message Name: ARI On/Off

Message Element Code: 21

Function: To switch ARI output signal "On" or "Off".

Format:

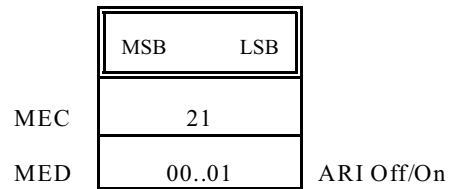

Conventions: "00" switches ARI "Off", "01" switches ARI "On".

Example: <21><00>

Switch the ARI output signal "Off".

3.1.45 Message Name: ARI area (BK)

Message Element Code: 0F

Function: To set the ARI area code.

Format:



Conventions: "00" switches the ARI Area modulation "Off".

Example: <0F><0A>

Switch ARI Area code to A.

3.1.46 Message Name: ARI level

Message Element Code: 1F

Function: To adjust the output level of the ARI subcarrier in mV_{p-p} for a specified Reference Table entry.

Format:

	MSB	LSB	
MEC	1F		
MED	0..7	0..1F	Bits 7..5: Reference Table entry Bits 4..0: ARI level MSB
MED	00..FF		ARI level LSB

Conventions: Reference "00" means that the level is related to all table entries, "1" to "6" identify a specific table entry, "7" is the currently selected table entry. The ARI level is expressed in the range from 0..8191 mV_{p-p} , and converted to a 13 Bit number.

Example: <1F><F4><07>

Set ARI level to 5127 mV_{p-p} on all Reference Table entries.

Request Message Command Format:

To request the ARI level, the following format is required:

	MSB	LSB	
MEC	17		
MEL	02		
MED	1F		Code of requested message
MED	00..07		Reference table entry

On a request, with reference table entry set to 0, the data of all reference table entries is returned in separate message elements.

3.1.47 Message Name: Site address**Message Element Code:** 23**Function:** To load or remove a site address in the encoder.**Format:**

	MSB	LSB	
MEC	23		
MED	00..03		Control Bits
MED	00..03		Site address high
MED	00..FF		Site address low

Conventions:

The range of permitted site addresses is 001..3FF hex (10 Bits).

The global site address "0" is always defined for the encoder. This address does not need to be included in a downloaded address list, and may not be cleared.

Manufacturers may choose to implement a special (individual) site address that cannot be changed or cleared with this command, to prevent lock-out

Significance of the two control bits:

<u>Bit 1</u>	<u>Bit 0</u>	
0	0	remove the specified site address from the list
0	1	add the specified site address to the list
1	0	remove all site addresses
1	1	not used

On a request all stored site addresses are returned in separate message elements with control bits set to Bit 1=0 and Bit 0=1.

Example:

<23><01><00><48>

Add the site address 0048 hex to the list of site addresses.

3.1.48 Message Name: Encoder address

Message Element Code: 27

Function: To load or remove an encoder address in the encoder.

Format:

	MSB	LSB	
MEC	27		
MED	00..03		Control Bits
MED	01..3F		Encoder address

Conventions: The range of permitted encoder addresses is 01..3F hex (6 Bits).

The global encoder address "0" is always defined for the encoder. This address does not need to be included in a downloaded address list, and may not be cleared.

Manufacturers may choose to implement a special (individual) encoder address that cannot be changed or cleared with this command.

Significance of the two control bits:

<u>Bit 1</u>	<u>Bit 0</u>	
0	0	remove the specified encoder address from the list
0	1	add the specified encoder address to the list
1	0	remove all encoder addresses
1	1	not used

On a request all stored encoder addresses are returned in separate message elements with control bits set to Bit 1=0 and Bit 0=1.

Example: <27><01><13>

Add the encoder address 13 (hex) to the list of encoder addresses.

3.1.49 Message Name: Make PSN list

Message Element Code: 28

Function: To assign one PSN as the main network service in the specified data set(s) and assign the other PSNs as other networks (EON).

Format:

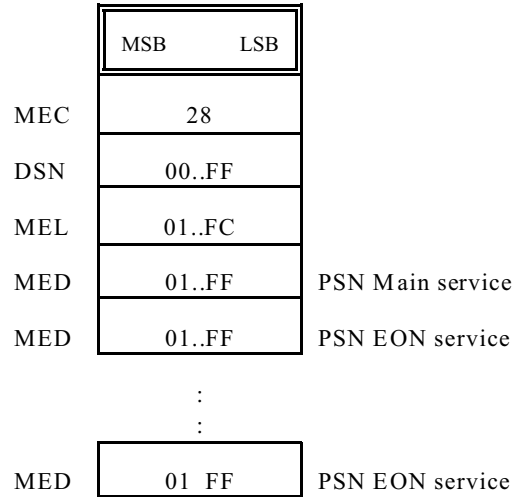

Conventions: This command establishes the Main service and the EON services which will be utilized in a given data set within the encoder. When issued, the command deletes all data in the specified data set and establishes the program services from this command. These services will need to be loaded using appropriate commands and then be enabled using the PSN enable command before the output is transmitted. The command is not permitted for the current data set.

Example: <28><02><05><03><01><04><09><2F>

In data set 2, assign PSN = 3 as the main service and the PSN's 1, 4, 9 and 47 as EON services.

3.1.50 Message Name: PSN enable/disable

Message Element Code: 0B

Function: To enable or disable a specified PSN.

Format:

	MSB	LSB	
MEC	0B		
DSN	00..FF		
MEL	02..FC		
MED	00..01		Bit 0: 0 disable PSN; 1 enable PSN
MED	01..FF		Index of PSN to be enabled/disabled
MED	00..01		
	:		
	:		
MED	00..01		
MED	01..FF		

Conventions: The main PSN may not be affected, addressing the main PSN will cause an error code.

Example: <0B><03><04><00><06><01><07>

Disable PSN 6 and enable PSN 7 in Data set 3.

3.1.51 Message Name: EON elements enable/disable

Message Element Code: 3F

Function: To enable or disable the transmission of a specific EON element for usage in group type 14 for specific PSNs and DSNs. This is achieved by switching on/off a particular Variant for transmission in 14A groups and, in the case of TA(ON), the Burst of 14B groups. MEC 3F supplements MEC 29 (page 97) with the possibility to disable specific elements in specific PSNs of the specific data set DSN.

Format:

	MSB	LSB	
MEC	3F		
DSN	00..FF		
PSN	00..FF		
MED	00..FF		1: enable 0: disable Bit 0: PS(ON) - Variants 0 to 3 of 14A Bit 1: AF(ON) - Variants 4 to 9 of 14A Bit 2: Linkage - Variant 12 of 14A Bit 3: PTY (ON) - Variant 13 of 14A Bit 4: PIN (ON) - Variant 14 of 14A Bit 5: Broadcasters use - Variant 15 of 14A Bit 6: Burst signalling of 14B Bit 7: Extended field - Reserved for future use
MED			[only if Bit 7 of previous MED is set to 1]

Conventions: Group types 14A and 14B are defined in IEC EN 62106:2000 / EN 50067:1998, Figures 37 and 38; the use of TA for EON is defined in Section 3.2.1.8.2.

Note: Variant 13 of the Group type 14A also contains the TA(ON) bit. However, in this particular Variant, TA(ON) serves only broadcast monitoring purposes and is not to be interpreted by a receiver for switching to a traffic announcement on an other network. This can only be accomplished with the Burst of 14B groups. Therefore, Control bit 6 permits to switch on or off each TA(ON) individually, to avoid simultaneous cross-referencing to traffic announcements on more than one other network..

Example: <3F><03><06><0B>

Enable PS(ON), AF(ON), PTY(ON) in Data set 3 for PSN 6.

3.1.52 Message Name: Communication mode ⁶⁾

Message Element Code: 2C

Function: To set the communication mode of the encoder.

Format:

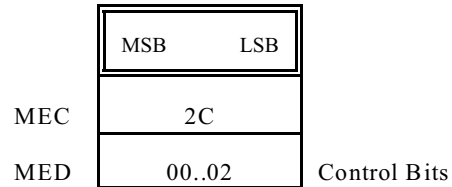

Conventions: 0 means unidirectional mode (see Section 1.3.1).
1 means bi-directional mode with requested response (see Section 1.3.2).
2 means bi-directional mode with spontaneous response (see Section 1.3.3); the sequence counter is set to 0.

Whenever this command is received, by an encoder, it must reset the sequence counter to a value of 1.

When changing from mode 2 to any other mode it will not be acknowledged.

Example: <2C><01>

The encoder is set to bi-directional mode with requested response.

⁶⁾ In new applications MEC 3B should be used, because it can specify the communication mode for individual ports.

3.1.53 Message Name: TA control

Message Element Code: 2A

Function: To control the generation of type 15B groups in the "On" and "Off" transition.

Format:

		MSB	LSB	
MEC		2A		
MED		00..08		Minimum number of other groups between two type 15B groups (0..8)
MED		0..F 0..F		Bits 7..4: Number of type 15B groups at TA "On" transition Bits 3..0: Number of type 15B groups at TA "Off" transition

Conventions: In the second MED, 0 specifies that no type 15B group is to be transmitted at the given transition. 1..E specifies the number of type 15B groups to be transmitted at the given transition. F means the type 15B groups should be transmitted continuously while the respective state is maintained.

Example: <2A><01><02>

Transmit two 15B groups, with a gap of >1< between two 15B groups, at the TA "Off" transition.

3.1.54 Message Name: EON - TA control

Message Element Code: 15

Function: To control the generation of type 14B groups in the "On" and "Off" transition.

Format:

	MSB	LSB	
MEC	15		
MED	00..08		Minimum number of other groups between successive 14B groups (0..8)
MED	0..F 0..F		Bits 7..4: Number of 14B groups at TA "On" transition Bits 3..0: Number of 14B groups at TA "Off" transition

Conventions: In the second MED, 0 specifies that no type 14B group is to be transmitted at the given transition. 1..E specify the number of type 14B groups to be transmitted at the given transition. F means the type 14B group should be transmitted continuously while the respective state is maintained.

Example: <15><01><02>

Transmit two type 14B groups, with a gap of >1< between two type 14B groups, at the TA "Off" transition.

3.1.55 Message Name: Reference input select**Message Element Code:** 1D**Function:** To select the 19 kHz reference input in the encoder and apply levels and phase from corresponding Reference Table entry.**Format:**

	MSB	LSB
MEC	1D	
MED	01..06	

Conventions: The Reference Table contains one entry corresponding to each reference input. Each table entry contains RDS level, RDS phase, ARI level (optional) and ARI phase (optional).**Example:** <1D><01>

Reference input number >1< is selected, as well as level and phase parameters for Reference Table entry number 1.

3.1.56 Message Name: Data set select

Message Element Code: 1C

Function: To select desired data set to be active ("on air").

Format:

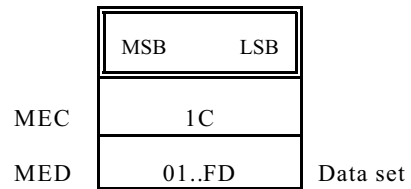

Example: <1C><17>

Select data set >23< to be active.

3.1.57 Message Name: Group sequence

Message Element Code: 16

Function: To set the group sequence in the specified data set(s).

Format:

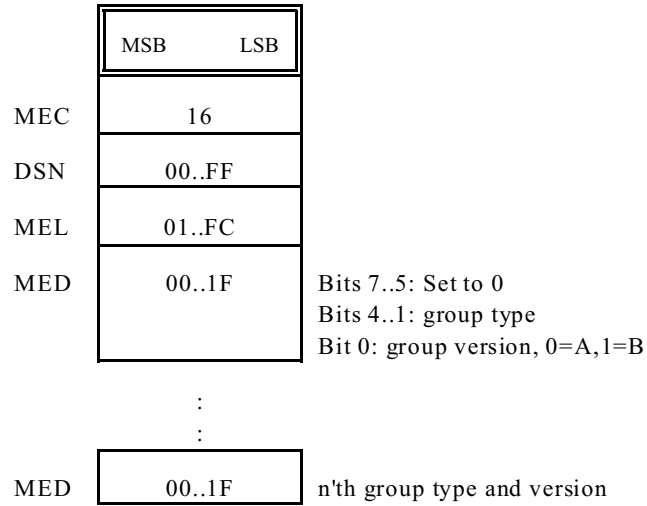

Example: <16><00><06><00><04><0E><1C><0D><00>

Set a new group sequence in the current data set as type 0A, 2A, 7A, 14A, 6B, 0A groups.

3.1.58 Message Name: Extended Group Sequence

Message Element Code: 38

Function: To set alternative group sequences for use when dynamic buffers are empty of data for particular groups.

Format:

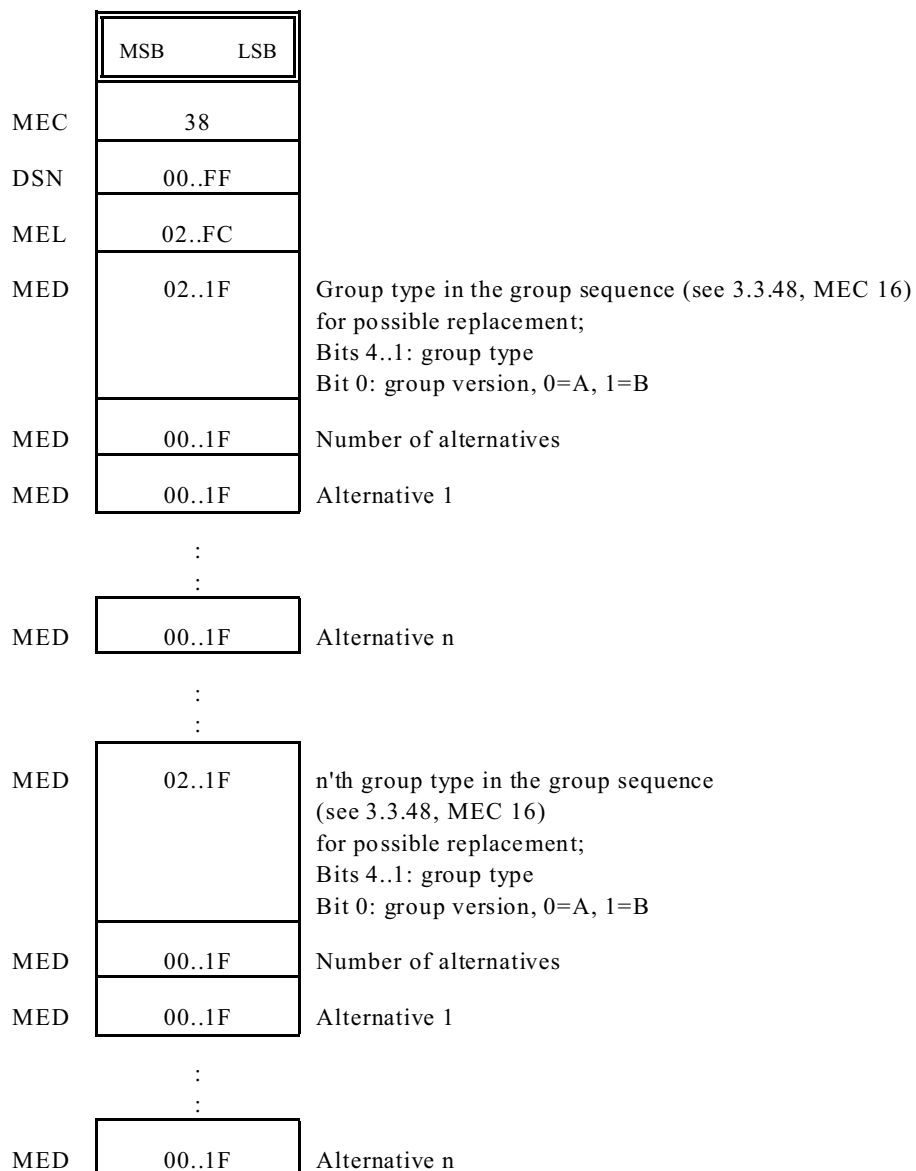

Convention: More than one alternative sequence is allowed for the same group type, the list of these alternative sequences being cycled through when there is no data for the replaced group. In the case where there are several alternative sequences for the same group type, the position in the list is not advanced if data is available for the particular group type.

Example:

<38><01><09><0E><03><10><0C><1C><0E><02><0C><00>

In data set 1, transmission of the first type 7A group should be replaced, if there is no data, by transmission of a type 8A group, or if the type 8A group buffer is empty by a type 6A group, or if the type 6A group buffer is empty by a type 14A group. The next transmission of a type 7A group for which there is no data should be replaced by transmission of a type 6A group or, if the type 6A buffer is empty, by a type 0A group. The following transmission of a type 7A group for which there is no data should be replaced by the alternatives sequence: type 8A, 6A, 14A groups.

0A,	2A,	7A,	14A,	7A,	0A,	6A,	2A,	7A,	group sequence
		8A		6A				8A	first alternate
		6A		0A				6A	second alternate
		14A						14A	final alternate

3.1.59 Message Name: Group variant code sequence

Message Element Code: 29

Function: To set the variant code sequence for a specified group type in the specified data set(s).

Format:

		MSB	LSB		
MEC		29			
DSN		00..FF			
MEL		02..FC			
MED		02,1C		Bits 4..1: group type	
				Bit 0: group version, 0=A, 1=B	
MED		00..0F		First Variant code	
				:	
				:	
MED		00..0F		nth Variant code	

Convention: Type 1A and 14A groups may be used. Other groups which do not utilize Variant codes will be ignored.

Example: <29><00><04><02><00><01><06>

Set a new variant code sequence for type 1A groups in the current data set as: >00, 01, 06<.

Request Message Command Format:

To request the group variant code sequence, the following format is required:

		MSB	LSB		
MEC		17			
MEL		03			
MED		29		Code of requested message	
MED		00..FF		DSN	
MED		02,1C		Bits 4..1: group type	
				Bit 0: group version	

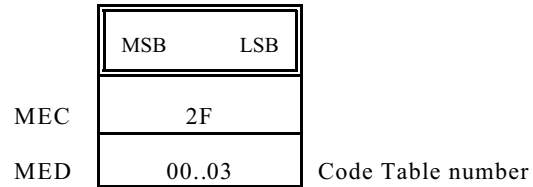
3.1.60 Message Name: PS Character code table selection**Message Element Code:** 2F**Function:** To select the code table number used by the encoder for PS transmission.**Format:****Conventions:** The encoder has to use the code table as specified in IEC EN 62106:2000 / EN 50067:1998 Annex E, Fig. E.1 is default.

Setting the MED to 00 indicates to the encoder that no control characters for code table selection will be transmitted.

Example: <2F><02>

Use code table of Figure E.2 in annex E of IEC EN 62106:2000 / EN 50067:1998.

3.1.61 Message Name: Encoder access right

Message Element Code: 3A

Function: To enable or disable access to any message on any port.

Format:

		MSB	LSB	
MEC		3A		
MED		00..FF		MEC of the command to be accessed FF: Special meaning (see Conventions)
MED		00..FF		0 = Current port 1 to 253 = Specific port 254 = All ports except current port 255 = All ports
MED		00..01		Bits 7..1: set to zero Bit 0: enable bit 0 = disabled 1 = enabled

Conventions: If a wrong or non-existent port number is specified, the encoder should respond with the Error message 06: "parameter out of range".

If a command is sent that attempts to lock-out the currently used port, the encoder must generate the Error message 09: "message not acceptable".

If the first MED is set to FF, the access right for all MECs on the specified port is modified, with the exception of MEC 3A, if the port concerned happens to be the actual port.

Example: <3A><3A><FE><00>

Coder access right (MEC 3A) is disabled on all other ports.

<3A><01><08><00>

PI change is disabled on port 8.

Request Message Command Format:

To request the access setting, the following format is required:

	MSB	LSB	
MEC	17		
MEL	03		
MED	3A		Code of requested message
MED	00..FF		MEC of the requested access right. If 254 or 255 specified, then data for all implemented MECs will be packed into separate message elements inside the same frame. But if this is too long for a single frame then the Error message 09: "not acceptable" will be generated.
MED	01..FF		Port number. If 0 is specified, then the Error message 06: "parameter out of range" will be generated.

3.1.62 Message Name: Communications port configuration - Mode

Message Element Code: 3B

Function: To set the mode of specified communications ports.

Format:

	MSB	LSB	
MEC	3B		
MED	00..FF		0 = Current port 1 to 253 = Specific port 254 = All ports except current port 255 = All ports
MED	00..02		00 Unidirectional mode 01 Bidirectional mode with requested response 02 Bidirectional mode with spontaneous response

Conventions: Communications modes are described in Section 2.3. Changing from Mode 2 to Modes 0 or 1 will not give a spontaneous response.

If a wrong or non-existent port number is specified, the encoder should respond with the Error message 06: "parameter out of range".

Example: <3B><00><01>

Set bidirectional mode with requested response to all ports

<3B><FF><02>

Set bidirectional mode with spontaneous response to currently used port

Request Message Command Format:

To request the mode setting, the following format is required:

	MSB	LSB	
MEC	17		
MEL	01 or 02		
MED	3B		Code of requested message
MED	00..FF		[Port number]. If 0 or none specified, then data for all installed ports will be packed into separate message elements inside the same frame. But if this is too long for a single frame then the Error message 09: "not acceptable" will be generated.

3.1.63 Message Name: Communications port configuration - Speed

Message Element Code: 3C

Function: To change speed of communications ports.

Format:

	MSB	LSB	
MEC	3C		
MED	00..FF		0 = Current port 1 to 253 = Specific port 254 = All ports except current port 255 = All ports
MED	00..0C		00 No action 01 75 bps 02 150 bps 03 300 bps 04 600 bps 05 1200 bps 06 2400 bps 07 4800 bps 08 9600 bps 09 19200 bps 0A 38400 bps 0B 57600 bps 0C 115200 bps

Conventions: This command must not be used with any other messages in the same frame to ensure the full response of the encoder is completed.

If a wrong or non-existent port number is specified, the encoder should respond with the Error message 06: "parameter out of range").

If Port 255 is selected then all ports will be affected by the command. Reply to this message, when bi-directional links are used, should use the original speed. All subsequent responses must be at the new speed.

Notes: Extreme care must be taken when changing speed of the "current" port. Setting the wrong speed may lock out all future communication. Therefore it is required that this command is sent twice to ensure reliability in making speed changes.

Firstly the command is sent at the "original" speed and then it is sent at the "new" speed; if the second command is not recognized by the encoder, within 60 seconds, it will revert to the "original" speed.

Example: <3C><02><08>

Change speed of port 2 to 9600 bps

<3C><00><05>

Set speed of currently used port to 1200 bps

Request Message Command Format:

To request the speed setting, the following format is required:

	MSB	LSB	
MEC	17		
MEL	01..02		
MED	3C		Code of requested message
MED	00..FF		[Port number]. If 0 or none specified, then data for all installed ports will be packed into separate message elements inside the same frame. But if this is too long for a single frame then the Error message 09: "not acceptable" will be generated.

3.1.64 Message Name: Communications Port Configuration - Timeout

Message Element Code: 3D

Function: To set a timer to indicate loss of data at a communications port of an encoder.

Format:

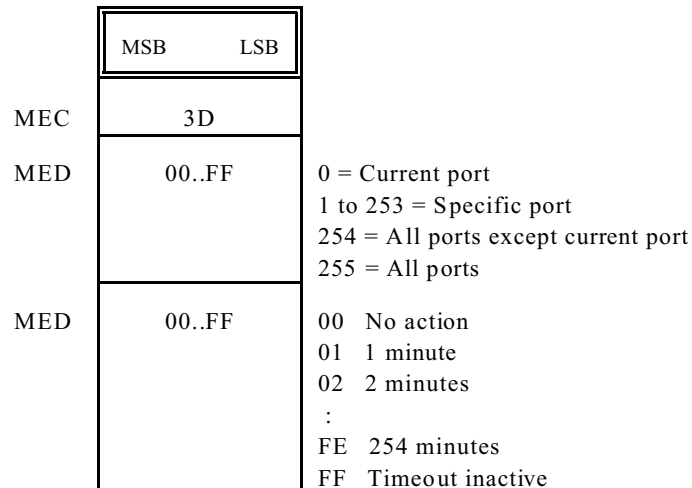

Conventions: This command is provided to allow the encoder to take specific action on loss of the data link.

If a wrong or non-existent port number is specified, the encoder should respond with the Error message 06: "parameter out of range".

Example: <3D><01><FF>

Disable timer associated with port 1

<3D><00><01>

Set timer for currently used port to 1 minute

Manufacturer specific response: for example an encoder may change Group Designation to zero, so that pagers scan for a new channel.

Request Message Command Format:

To request the timeout setting, the following format is required:

	MSB	LSB	
MEC	17		
MEL	01 or 02		
MED	3D		Code of requested message
MED	00..FF		[Port number]. If 0 or none specified, then data for all installed ports will be packed into separate message elements inside the same frame. But if this is too long for a single frame then the Error message 09: "not acceptable" will be generated.

3.1.65 Message Name: Message acknowledgment

Message Element Code: 18

Function: Messages used to report acknowledgment of received messages.

Format:

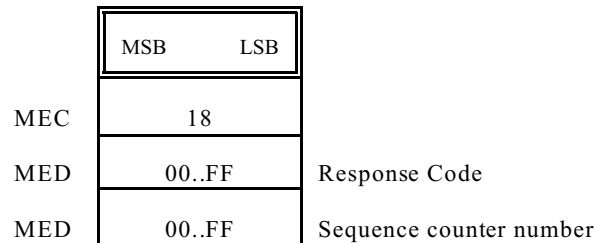

Conventions: The response code is as follows:

- 0 = Message received OK
- 1 = CRC error has occurred: Message is wrong
- 2 = Message was not received (derived from the sequence counter)
- 3 = Message unknown
- 4 = DSN error
- 5 = PSN error
- 6 = Parameter out of range
- 7 = Message element length error
- 8 = Message field length error
- 9 = Message not acceptable
- 10 = End message (FF hex) missing
- 11 = Buffer overflow
- 12 = Bad stuffing, after FD hex a number outside the range 00 to 02 has been received
- 13 = Unexpected end of message (FF hex) received
- 14 - 255 = Undefined

The Sequence counter number is a copy of the sequence counter of the received message reflected by the response. This field is sent only if an error occurred, otherwise, if transmission is OK, this field is not transmitted. In this case, response reflects to last message (bi-directional communication mode 2) or to all messages after last response (bi-directional communication mode 1). If the sequence counter number cannot be determined due to errors, then 00 hex is used.

When multiple commands are sent in one message frame the encoder may either return a frame containing one message acknowledgement for each command in the received frame, or a single acknowledgement if all commands in the frame were correctly received or the error is a global error related to the whole message frame.

This MEC can only be requested in bi-directional mode, requested response.

Example: <18><00>

In the bi-directional mode 1: All messages after the last response were correctly received. In the bi-directional mode 2: the last message was correctly received.

<18><02><42> means that sequence number 42 hex is wrong.

3.1.66 Message Name: Request message

Message Element Code: 17

Function: To request specific message to be replied by the encoder.

Format:

		MSB	LSB	
MEC		17		
MEL		01..FD		
MED		00..FF		Code of requested message
MED		00..FF		[DSN] if required
MED		00..FF		[PSN] if required
MED		00..FF		Further information if required
		:		
		:		
MED		00..FF		Further information if required

Conventions: The Request Message code is the code of a message to be answered, i.e. most Message Element Codes can be requested, in the same format and length as defined.

The encoder may either respond with the requested message immediately, or may respond with a message acknowledgement and then send the requested message for which the server may send a message acknowledgement.

The presence of DSN and PSN is dependent on the Request Message code and [DSN] and [PSN] are included in conformity with the code that is requested.

Request of the following MEC's needs additional information:

- MEC 13 (AF) requires start location,
- MEC 14 (EON-AF) requires start location,
- MEC 29 (Group variant code sequence) requires group type and version,
- MEC 22 (RDS phase) requires reference table entry,
- MEC 0E (RDS level) requires reference table entry,
- MEC 1F (ARI level) requires reference table entry,
- MEC 0A (RT) requires the index of the Radiotext in the Radiotext buffers,
- MEC 3A (Access right) requires port number and the MEC concerned,
- MEC 3B (Port communication mode) requires port number,
- MEC 3C (Port baud rate configuration) requires port number,
- MEC 3D (Port timeout) requires port number.
- MEC 1A (Slow labeling codes) requires variant code

Details for the request message replies for each of these cases are given on the pages referring to the MEC's.

The following MEC's cannot be requested: MEC 17 (Request message), MEC 2D (Manufacturer's specific command) and all the paging call commands.

Transparent data commands (TDC, EWS, IH, TMC, Free-format group) will return only the contents of cyclic buffers.

Example:

<17><02><1A><01>

Means that the Request message code is 1A for DSN 01 hex.

3.1.67 Message Name: Manufacturer / Transmission operator specific command

Message Element Code: 2D

Function: The content and meaning of this command is manufacturer or transmission operator dependant.

Format:

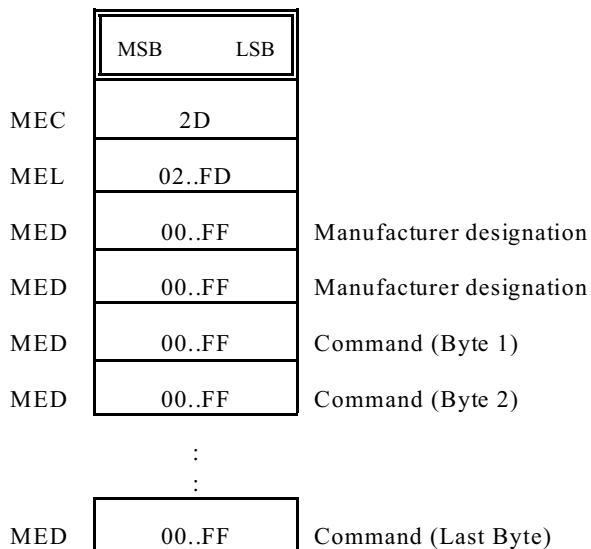

Conventions: This command can be used by the manufacturer to implement any manufacturer dependent special feature. The manufacturer designation consists of two bytes. The meaning of the command must be specified by the manufacturer.

Example: <2D><06><4D><41><12><34><56><78>

The notional manufacturer/operator “MA” sends a command having a length of 4 bytes comprising >12345678<.

3.1.68 Message Name: Astra ADR special commands

In 1995, the ASTRA Digital Radio service started its operation. The Institut für Rundfunktechnik IRT in München had studied its potential for its use to provide programme and data links to FM transmitters. This study led to adopting the UECP for inclusion into the ADR transmission standard, and it is thus possible to feed RDS encoders directly via the satellite. This will not only facilitate, but also permit to significantly reduce cost for the implementation of dynamic RDS features within large FM networks. A limited set of 17 commands (MEC EC to FC) has been reserved to address ADR equipment specific functionality.

These commands are defined in:

ASTRA Digital Radio (ADR), January 1999, Issue 1.5. This specification can be obtained from. Société Européenne des Satellites, Technical Marketing Services, L6815 Château de Betzdorf, Luxembourg.

Appendix 1

CCITT Polynomial

1. Introduction

The CRC is a cyclic redundancy check carried out on data to allow error checking to take place.

The field consists of four hexadecimal characters representing a 16 bit calculation. The divisor polynomial used to generate the CRC is:

$$x^{16} + x^{12} + x^5 + 1$$

The CRC calculation starts with the most significant bit of the field immediately following the start character and ends with the least significant bit of the character immediately preceding the first CRC character.

The CRC is initialized to a value of FFFF(hex) and the four CRC characters are formed from the INVERSE of the result of the CRC calculation. The four most significant bits are represented by the first CRC field character.

2. PASCAL listing of CCITT CRC calculation routine

Type STRING is a PACKED ARRAY of CHAR with zero'th element holding the length of the string:

SWAP is a library function which swaps the high- and low-order bytes of the argument e.g.

```
VAR X: WORD;  
  
BEGIN  
  X:= SWAP ($1234)      [$3412]  
END;
```

LO is a library function which returns the low-order byte of the argument e.g.

```
VAR W: WORD;  
  
BEGIN  
  W:= LO ($1234)       [$34]  
END;
```

```
FUNCTION CRCVALUE (STRINGTOEVAL : STRING): INTEGER;
VAR
COUNT: BYTE;
TEMPCRC: WORD;
BEGIN
    TEMPCRC:= $FFFF;
    FOR COUNT:= 1 TO LENGTH (STRINGTOEVAL) DO
        BEGIN
            TEMPCRC:= SWAP (TEMPCRC) XOR ORD (STRINGTOEVAL [COUNT]);
            TEMPCRC:= TEMPCRC XOR (LO (TEMPCRC) SHR 4);
            TEMPCRC:= TEMPCRC XOR (SWAP (LO (TEMPCRC)) SHL 4) XOR
                (LO (TEMPCRC) SHL 5)
        END;
    CRCVALUE:= TEMPCRC XOR $FFFF
END; [OF FUNCTION CRCVALUE]
```

3. Example

When applied to the string:

2D111234010105ABCD123F0XXXX11069212491000320066

The range of each of these 47 characters is 00..FF and the CRC generated and then appended will be:

97 23 hex.

Appendix 2

Glossary

Alternative Frequencies (AF)

The list(s) of alternative frequencies give information on the various transmitters broadcasting the same programme in the same or adjacent reception areas, and enable receivers equipped with a memory to store the list(s), to reduce the time for switching to another transmitter. This facility is particularly useful in the case of car and portable radios. One of two Methods, A or B, can be used. Their protocols are explained in 3.2.1.6 of IEC EN 62106:2000 / EN 50067:1998.

Clock-time and date (CT)

In application of the relevant CCIR Recommendations, broadcast time and date codes should use Coordinated Universal Time (UTC) and Modified Julian Day (MJD). Details of using these codes are given in 3.2.3 and annex G of IEC EN 62106:2000 / EN 50067:1998. The listener, however, will not use this information directly and the conversion to local time and date will be made in the receiver's circuitry.

Decoder Identification (DI) and dynamic PTY Indicator (PTYI)

These bits indicate which possible operating modes are appropriate for use with the broadcast audio and to indicate if PTY codes are switched dynamically. Details of using these codes are given in 3.2.1.5 of IEC EN 62106:2000 / EN 50067:1998.

Enhanced other networks information (EON)

This feature can be used to update the information stored in a receiver about programme services other than the one received. Alternative frequencies, the PS name, Traffic-programme and announcement identification as well as Programme-type and Programme-item-number information can be transmitted for each other service. The relation to the corresponding programme is established by means of the relevant programme identification (see 3.2.1.8 of IEC EN 62106:2000 / EN 50067:1998). Linkage information (see 3.2.1.8.3 of IEC EN 62106:2000 / EN 50067:1998), consisting of four data elements, provides the means by which several programme services may be treated by the receiver as a single service during times a common programme is carried.

Emergency warning systems (EWS)

The EWS feature is intended to provide for the coding of warning messages that for reasons of secrecy cannot be fully detailed. These messages will be broadcast only in cases of extreme emergency and will only be evaluated by special receivers that will automatically tune to the channel carrying the corresponding identification (see 3.2.7 of IEC EN 62106:2000 / EN 50067:1998).

In-house application (IH)

This refers to data to be decoded only within the broadcasting organization. Some examples noted are identification of transmission origin, remote switching of networks and paging of staff. The applications of coding may be decided by each broadcasting organization itself.

Music/speech switch (M/S)

This is a two-state signal to provide information on whether music or speech is being broadcast. The signal would permit receivers to be equipped with two separate volume controls, one for music and one for speech, so that the listener could adjust the balance between them to suit his individual listening habits.

ODA - Open Data Applications

The Open Data Applications feature allows data applications, not specified in IEC EN 62106:2000 / EN 50067:1998, to be conveyed in a number of allocated groups in an RDS transmission. The groups allocated are indicated by the use of type 3A group which is used to identify to a receiver the data application in use in accordance with the registration details in the EBU/RDS Forum - Open Data Applications Directory.

Programme identification (PI)

This information consists of a code enabling the receiver to distinguish between countries, areas in which the same programme is transmitted, and the identification of the programme itself. The code is not intended for direct display and is assigned to each individual radio programme, to enable it to be distinguished from all other programmes. One important application of this information would be to enable the receiver to search automatically for an alternative frequency in case of bad reception of the programme to which the receiver is tuned; the criteria for the change-over to the new frequency would be the presence of a better signal having the same programme identification code.

Programme-item number (PIN)

The code should enable receivers and recorders designed to make use of this feature to respond to the particular programme item(s) that the user has preselected. Use is made of the scheduled programme time, to which is added the day of the month in order to avoid ambiguity (see 3.2.1.7 of IEC EN 62106:2000 / EN 50067:1998).

Programme service (PS) name

This is a text consisting of not more than eight alphanumeric characters coded in accordance with annex E of IEC EN 62106:2000 / EN 50067:1998, which is displayed by RDS receivers in order to inform the listener what programme service is being broadcast by the station to which the receiver is tuned. An example for a name is "Radio 21". In the case of a local programme, the broadcaster may use any designation (up to 8 characters).

Programme type (PTY)

This is an identification number to be transmitted with each programme and which is intended to specify the programme type within 31 possibilities (see annex F of IEC EN 62106:2000 / EN 50067:1998). This code could also be used for search tuning. The code will, moreover, enable suitable receivers and recorders to be pre-set to respond only to programme items of the desired type. The last number, i.e. 31, is reserved for an alarm identification which is intended to switch on the audio signal when a receiver is operated in a waiting reception mode.

Programme TYPe Name (PTYN)

The PTYN feature is used to further describe current PTY. PTYN permits the display of a more specific PTY description that the broadcaster can freely decide (eg PTY=4: Sport and PTYN: Football). The PTYN is not intended to change the default eight characters of PTY which will be used during search or wait modes, but only to show in detail the programme type once tuned to a programme. If the broadcaster is satisfied with a default PTY name, it is not necessary to use additional data capacity for PTYN. The Programme Type Name is not intended to be used for automatic PTY selection and must not be used for giving sequential information.

Radio paging (RP)

The RP Feature is intended to provide radio paging using the existing VHF/FM broadcasts as a transport mechanism, thereby avoiding the need for a dedicated network of transmitters. Subscribers to a paging service will require a special pocket paging receiver in which the subscriber address code is stored. Two kinds of Radio paging exist:

- The basic Radio paging
- The Enhanced Paging Protocol (EPP)

In the basic Radio paging, four types of call messages are possible:

- a simple call (bleeper) without message,
- a 10 or 18 digit numeric message, restricted to 15 digits in international paging,
- an alphanumeric message of up to 80 characters,
- a functions message in international paging.

In the Enhanced Paging Protocol, a complete set of variable length messages is added to the four types listed above. These variable length messages are:

- national or international numeric,
- national or international alphanumeric,
- national or international functions.

Radiotext (RT)

This refers to text transmissions coded in accordance with annex E, primarily addressed to home receivers, equipped with suitable display facilities. In car receivers where a text display is undesirable for safety reasons, the Radiotext transmission could be used to control a speech synthesizer; details of operation in this mode require further study.

Traffic-announcement identification (TA)

This is an on/off switching signal to indicate whether an announcement for motorists is on the air. The signal could be used in receivers to:

- a) switch automatically from any audio mode to the traffic announcement;
- b) switch on the traffic announcement automatically when the receiver is in a waiting reception mode and the audio signal is muted;
- c) switch from a programme carrying no traffic information to one carrying a traffic announcement, according to those possibilities which are given in 3.2.1.3 or 3.2.1.8.2 of IEC EN 62106:2000 / EN 50067:1998.

After the end of the traffic announcement the initial operating mode will be restored.

Transparent data channel (TDC)

As well as for the application described above, Radiotext could also be sent in a form suitable for presenting a display on a television receiver similar to that obtained with teletext. These channels may be used to send alphanumeric characters, or other text (including mosaic graphics), or for transmission of computer programs and similar data not for display.

Traffic Message Channel (TMC)

This feature is intended to be used for the coded transmission of traffic information. Type 8A/3A or 8A/1A groups may be used for this purpose and details are described in the TMC specific standards issued by CEN (see the ENV/12313-... family of standards).

Traffic-programme identification (TP)

This is an on/off switching signal to indicate, by means of a special lamp (or a similar device) on the receiver, that this is a programme on which announcements are usually made for motorists. The signal could be taken into account during automatic search tuning.

Index of abbreviations

The abbreviations which are commonly used in context with the Radio Data System are listed below in alphabetical order. Most of these terms are explained in the preceding glossary.

1. RDS features:

AF	List of alternative frequencies
CT	Clock time and date
DI	Decoder identification
EON	Enhanced information on other networks
EWS	Emergency warning systems
IH	In-house application
M/S	Music/speech switch
ODA	Open data application
PI	Programme identification
PIN	Programme-item number
PS	Programme service name
PTY	Programme type
PTYI	Programme type indicator (static/dynamic)
PTYN	Programme type name
RDS	Radio Data System
RP	Radio paging
RT	Radiotext
TA	Traffic-announcement identification
TDC	Transparent data channel
TMC	Traffic message channel (Application under discussion)
TP	Traffic-programme identification

2. Other abbreviations:

ADI	Application identification for Open data (see 3.1.5.4 of IEC EN 62106:2000 / EN 50067:1998)
ARI	Identification system for broadcasts to motorists (CCIR Report 463 and annex H of IEC EN 62106:2000 / EN 50067:1998)
CI	Country identifier (see 3.2.1.8.3 of IEC EN 62106:2000 / EN 50067:1998)
ECC	Extended country code (see annex D of IEC EN 62106:2000 / EN 50067:1998)
EG	Extended Generic indicator (see 3.2.1.8.3 of IEC EN 62106:2000 / EN 50067:1998)
ILS	International Linkage Set indicator (see 3.2.1.8.3 of IEC EN 62106:2000 / EN 50067:1998)
LA	Linkage Actuator (see 3.2.1.8.3 of IEC EN 62106:2000 / EN 50067:1998)
LI	Linkage Identifier (see 3.2.1.8.3 of IEC EN 62106:2000 / EN 50067:1998)
LSN	Linkage Set Number (see 3.2.1.8.3 of IEC EN 62106:2000 / EN 50067:1998)
UECP	Universal Encoder Communications Protocol

3. RDS Paging abbreviations:

CCF	Current Carrier Frequency (see Figure 8 b of RDS Paging WG Doc. 2, Sept. 1994)
CS	Cycle Selection (see 3.2.8.4.1.3 of RDS Paging WG Doc. 2, Sept. 1994)
EPP	Enhanced Paging Protocol (see 3.2.8. of RDS Paging WG Doc. 2, Sept. 1994)
IT	Paging interval (see 3.8.4.1.3 of RDS Paging WG Doc. 2, Sept. 1994)
OPC	Operator Code (see 3.2.8.2 of RDS Paging WG Doc. 2, Sept. 1994)
PAC	Paging Area Code (see 3.2.8.2 of RDS Paging WG Doc. 2, Sept. 1994)
SI	System Information (see 3.2.8.2 of RDS Paging WG Doc. 2, Sept. 1994)
STY	Sub-type of type 13A group (see 3.2.8.4.1.3 of RDS Paging WG Doc. 2, Sept. 1994)

Appendix 3

Identification of manufacturers and transmission operators for the Manufacturer's specific command

The list of codes is historically comprehensive, but does not imply that a particular manufacturer or network operator is supplying RDS equipment, systems or services. The RDS Forum takes no responsibility for, nor does it recommend, any organisation listed. It is the responsibility of a user to ensure that products and services meet his needs.

Manufacturer	Assigned id.	hex code
Acorn, Slovenia	AC	<41><43>
AEV, Italy	AE	<41><45>
ARD, Germany	AR	<41><52>
Auditem, France	AU	<41><55>
Aztec, France	AZ	<41><5A>
Cambridge Systems Technology, UK	CA	<43><41>
Cepar, Italy	CE	<43><45>
CRL Inc., USA	CR	<43><52>
Deutsche Telekom, Germany	DT	<44><54>
Digital Instruments	DI	<44><49>
Ericsson, Sweden	TE	<54><45>
Gian Technologies, USA	GI	<47><49>
Inovonics Inc., USA	IN	<49><4E>
Itelco SpA, Italy	IT	<49><54>
KK Data, Denmark	KK	<4B><4B>
Link Comunicaciones, Spain	LI	<4C><49>
Munter, Italy	MU	<4D><55>
Modulation Sciences., USA	MS	<4D><53>
Noesis SA, Greece	NS	<4E><53>
OAO Izhevskiy Radiozavod, Russia	OA	<4F><41>
Proflin, Netherlands	PR	<50><52>
RE Technology AS, Denmark	RE	<52><45>
Rohde & Schwarz, Germany	RS	<52><53>
Schümperlin Engineering, Switzerland	SE	<53><45>
Siel, Italy	SI	<53><49>
Suono Telecom, Italy	SU	<53><55>
Télédiffusion de France, France	TD	<54><44>
Telefunken, Germany	TF	<54><46>
Teleray, Slovenia	TR	<54><52>
Teracom, Sweden	TC	<54><43>
Tiesseci, Italy	TI	<54><49>
Vevec, France	VE	<56><45>
VG Broadcast, UK	VG	<56><47>
2wcom, Germany	WW	<57><57>

Note: Manufacturers of encoders or Transmission operators, worldwide, not included in the list, may apply for a code assignment to the RDS Registrations Office, RDS Forum, Av. des Tilleuls 3-B02, CH 1203 Geneva, Switzerland (**contact Mr. Dietmar Kopitz, Tel. +41 22 340 23 42, Fax. +41 22 340 23 43, E-mail: DKopitz@compuserve.com**). The nominal fee for the registration is 300 Euro, payable in advance. Information on RDS and the RDS Forum is available on <http://www.rds.org.uk>.

Index of RDS message commands

MEC	Page	Function
01	23	PI
02	24	PS
03	27	TA/TP
04	26	DI/PTYI
05	28	MS
06	25	PIN
07	29	PTY
08	61	Paging call with numeric message (10 digits)
09	76	Real time clock correction
0A	31	RT
0B	87	PSN enable/disable
0C	60	Paging call without message
0D	75	Real time clock
0E	80	RDS level
0F	82	ARI area (BK)
10	65	International paging with functions message
11	64	International paging with numeric message (15 digits)
12	66	Transmitter network group designation
13	34	AF
14	36	EON - AF
15	91	EON - TA control
16	94	Group sequence
17	109	Bi-directional commands (Remote and configuration commands) Request message
18	107	Bi-directional commands (Remote and configuration commands) Message acknowledgment
19	77	CT On/Off
1A	38	Slow Labeling codes
1B	63	Paging call with alphanumeric message (80 characters)
1C	93	Data set select
1D	92	Reference input select
1E	78	RDS On/Off
1F	83	ARI level
20	62	Paging call with numeric message (18 digits)
21	81	ARI On/Off
22	79	RDS phase
23	84	Site address
24	59	Free-format group
25	57	IH
26	55	TDC
27	85	Encoder address
28	86	Make PSN list
29	97	Group variant code sequence
2A	90	TA control
2B	56	EWS
2C	89	Communication mode
2D	111	Manufacturer's / Network operator's specific command
2E	39	Linkage information
2F	98	PS character code table selection
30	58	TMC
31	67	EPP transmitter information
32	68	EPP call without additional message
33	69	EPP national and international call with alphanumeric message
34	71	EPP national and international call with variable length numeric message
35	73	EPP national and international call with variable length functions message
38	95	Extended group sequence
3A	99	Encoder access right
3B	101	Communications Port Configuration - Mode
3C	103	Communications Port Configuration - Speed
3D	105	Communications Port Configuration - Timeout
3E	30	PTYN
3F	88	EON elements enable/disable
40	40	ODA configuration and short message command
41	42	ODA identification group usage sequence
42	44	ODA free-format group
43	46	ODA relative priority group sequence
44	47	ODA "Burst mode" control
45	48	ODA "Spinning Wheel" timing control
46	50	ODA data
47	53	ODA data command access right
EC to FC	112	Astra ADR 3) special commands (Reserved range)

RDS Universal Encoder Communication Protocol

UECP Version 6.01

Document history

Date	Doc Title	Paper type/Details	Location	file name
February 94	SPB 490 (revised)	Green - double sided	Geneva	
April 94	SPB 490 (2nd Revision)	White - single sided	Geneva	SPB490E2.wpd
September 94	Working Party notes	Not printed	Kingswood Warren	spb490e3.wpd
October 94	SPB 490 (3rd Revision)	Blue - double sided	Kingswood Warren	spb490e4.wpd
May '95	SPB 490 (4th Revision)	Used at meeting	Berlin	spb490e5.wpd
May '95	SPB 490 (4th Revision)	Updated after meeting 26.05.95 for review by drafting group	Berlin	spb490e6.wpd
June '95	SPB 490 (4th Revision)	Updated after Working Group comments - for issue to RDS Forum	Geneva	spb490e7.wpd
May '97	SPB 490 (5th Revision) Version 5.0	Updated after Working Group 5 meeting - for issue to 9 th RDS Forum, Metz '97	Geneva	s490e50.wpd
August '97	SPB 490 (5th Revision) Version 5.1	Revised after review by members of RDS Forum Working Group 5	Geneva	s490e51.wpd
November '01	SPB 490 (6th Revision) Version 6.0	Revised after review by members of RDS Forum Working Group 5	Geneva	UECP_6_0.wpd
June '02	SPB 490 (6th Revision) Version 6.0 - Final draft	Editorially corrected after review by members of RDS Forum Working Group 5	Geneva	UECP_6_0_final draft.wpd
June '03	SPB 490 (6th Revision) Final Version 6.0	Editorially corrected after review by members of RDS Forum Working Group 5	Geneva	UECP_6_0_final _030521.wpd
June '03	SPB 490 (6th Revision) Final Version 6.01	Editorially corrected. PTYI was missing in MEC 04.	Geneva	UECP_6_01_fina l_030612.wpd
Sept. '06	SPB 490 (6th Revision) Final Version 6.02	Update of Appendix 3	Geneva	UECP_6_02_fina l_060912.wpd

Dietmar Kopitz

Issue: 5

Date: 2006-09-12

DK>C:\DK_Office_RDS Forum_Dell\Work_2003\RDS Forum_03\UECP\UECP_6_02_final_060912.wpd